



SPECTRUM
SYSTEMENTWICKLUNG MICROELECTRONIC GMBH

MX.72xx

**digital pattern generator
with programmable logic levels
for PXI bus**

**Hardware Manual
Driver Manual**

English version

January 25, 2012

(c) SPECTRUM SYSTEMENTWICKLUNG MICROELECTRONIC GMBH
AHRENSFELDER WEG 13-17, 22927 GROSSHANSDORF, GERMANY

SBench is a registered trademark of Spectrum Systementwicklung Microelectronic GmbH.

Microsoft, Visual C++, Visual Basic, Windows, Windows 98, Windows NT, Window 2000 and Windows XP, Windows Vista, Windows 7 are trademarks/registered trademarks of Microsoft Corporation.

LabVIEW, DASyLab, Diadem and LabWindows/CVI are trademarks/registered trademarks of National Instruments Corporation.

MATLAB is a trademark/registered trademark of The Mathworks, Inc.

Agilent VEE, VEE Pro and VEE OneLab are trademarks/registered trademarks of Agilent Technologies, Inc.

FlexPro is a registered trademark of Weisang GmbH & Co. KG.

Introduction.....	6
Preface	6
General Information	6
Different models of the MX.72xx series	7
The Spectrum type plate	8
Hardware information.....	9
Block diagram.....	9
Order information.....	10
Hardware Installation	11
System Requirements	11
Warnings.....	11
ESD Precautions	11
Cooling Precautions.....	11
Sources of noise.....	11
Installing the board in the system.....	11
Installing a single board without any options.....	11
Installing a single MX.7220 board without any options.....	12
Software Driver Installation.....	13
Interrupt Sharing	13
Important Notes on Driver Version 4.00.....	13
Windows XP 32/64 Bit	14
Installation	14
Version control.....	14
Driver - Update.....	15
Windows Vista/7 32/64 Bit	16
Installation	16
Version control.....	17
Driver - Update.....	17
Windows NT / Windows 2000 32 Bit.....	18
Installation	18
Adding boards to the Windows NT / Windows 2000 driver.....	18
Driver - Update.....	18
Important Notes on Driver Version 4.00.....	18
Linux.....	19
Overview	19
Installation	19
Software	21
Software Overview.....	21
C/C++ Driver Interface.....	21
Header files	21
Microsoft Visual C++	22
Borland C++ Builder.....	22
Linux Gnu C.....	22
Other Windows C/C++ compilers	22
National Instruments LabWindows/CVI.....	23
Driver functions	23
Delphi (Pascal) Programming Interface	25
Type definition	25
Include Driver.....	25
Examples.....	25
Driver functions	25
Visual Basic Programming Interface	27
Include Driver.....	27
Visual Basic Examples.....	27
VBA for Excel Examples	27
Driver functions	27

Programming the Board	29
Overview	29
Register tables	29
Programming examples.....	29
Error handling.....	29
Initialization.....	30
Starting the automatic initialization routine	30
PCI Register	30
Hardware version.....	31
Date of production.....	31
Serial number	31
Maximum possible sample rate	31
Installed memory	31
Installed features and options.....	32
Used interrupt line	32
Used type of driver.....	32
Example program for the board initialization	33
Powerdown and reset.....	33
Digital Outputs	34
Channel Selection	34
Important note on channels selection.....	34
Setting up the bitmask.....	34
Setting up the outputs.....	35
Programming the output levels.....	35
Single-ended outputs	36
Differential outputs.....	36
Programming the behavior after replay	37
Reading the output status register	38
General information.....	38
Important Note on reading out the status register.....	39
Example program.....	39
Standard generation modes	40
General description.....	40
Singleshot mode.....	40
Continuous Mode	40
Posttrigger Mode.....	40
Programming	40
Partitioning the memory.....	40
Starting without interrupt (classic mode).....	42
Starting with interrupt driven mode	42
Data organization	43
Writing data with SpcSetData.....	43
Sample format.....	44
FIFO Mode.....	45
Overview	45
General Information.....	45
Background FIFO Write.....	45
Speed Limitations.....	45
Programming	46
Software Buffers	46
Buffer processing.....	47
FIFO mode	48
Example FIFO generation mode	48
Data organization	49
Sample format.....	49
Clock generation	50
Overview	50
Internally generated sample rate	50
Standard internal sample rate	50
Using plain quartz without PLL.....	51
External reference clock	51
Direct external clock	51
External clock with divider.....	53
PXI Reference Clock	53

Trigger modes and appendant registers	54
General Description.....	54
Software trigger	54
External TTL trigger	54
Edge triggers	55
PXI Features	57
Background on PXI	57
PXI and CompactPCI.....	57
PXI Reference Clock.....	57
PXI Star Trigger	57
PXI Trigger Bus.....	57
PXI Interconnect Bus.....	57
Programming PXI Features	58
PXI Reference Clock.....	58
PXI Trigger Modes	58
Option Multiple Replay	61
Output modes	61
Standard Mode.....	61
FIFO Mode.....	61
Trigger modes.....	61
Option Gated Replay	63
Output modes	63
Standard Mode.....	63
FIFO Mode.....	63
Trigger modes.....	63
General information and trigger delay	63
Alignement samples per channel	64
Number of samples on gate signal	64
Allowed trigger modes	65
Example program.....	65
Appendix	66
Error Codes.....	66
Pin assignment of the multipin connector	67
Main digital outputs.....	67
Pin assignment of the multipin cable	67
IDC footprints.....	68

Introduction

Preface

This manual provides detailed information on the hardware features of your Spectrum instrumentation board. This information includes technical data, specifications, block diagram and a connector description.

In addition, this guide takes you through the process of installing your board and also describes the installation of the delivered driver package for each operating system.

Finally this manual provides you with the complete software information of the board and the related driver. The reader of this manual will be able to integrate the board in any PC system with one of the supported bus and operating systems.

Please note that this manual provides no description for specific driver parts such as those for LabVIEW or MATLAB. These drivers are provided by special order.

For any new information on the board as well as new available options or memory upgrades please contact our website <http://www.spectrum-instrumentation.com>. You will also find the current driver package with the latest bug fixes and new features on our site.



Please read this manual carefully before you install any hardware or software. Spectrum is not responsible for any hardware failures resulting from incorrect usage.

General Information

The MX.72xx pattern generator series gives the user the possibility to generate digital data with a wide range of output levels.

The MX.72xx pattern generator series gives the user the possibility to generate digital data with a wide range of output levels. For every 4 bit the LOW and HIGH levels can be programmed from -2.0 V up to +10.0 V. Even at high speeds you are not limited concerning the maximum output swing. This enables the user to drive devices of nearly any logic family, like ECL, PECL, TTL, LVDS, LVTTTL, CMOS or LVC MOS. The potentially necessary differential signals are generated in hardware, so that only one data bit is used for each pair of differential signals. All outputs can be separately disabled allowing the easy connection with digital acquisition boards and the adaption to a wide range of test setups. This is mostly usefull if devices with I/O pins are tested.

The standard bus allows synchronisation of several MX.xxxx boards. Therefore the MX.72xx board can be used as an enlargement to any digital or analog board.

Application examples: Production test, Burn-in test, Laborytory purposes, Pattern generator, Semiconductor development, ATE.

Different models of the MX.72xx series

The following overview shows the different available models of the MX.72xx series. They differ in the number of available channels. You can also see the model dependant allocation of the output connectors.

- **MX.7210**

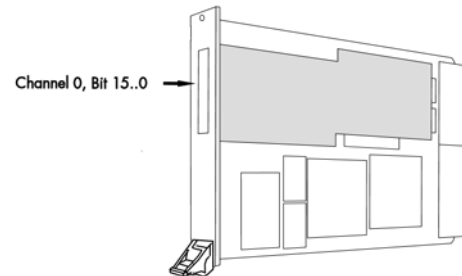

- **MX.7220**

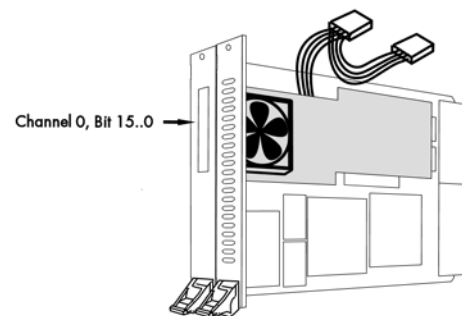

The Spectrum type plate

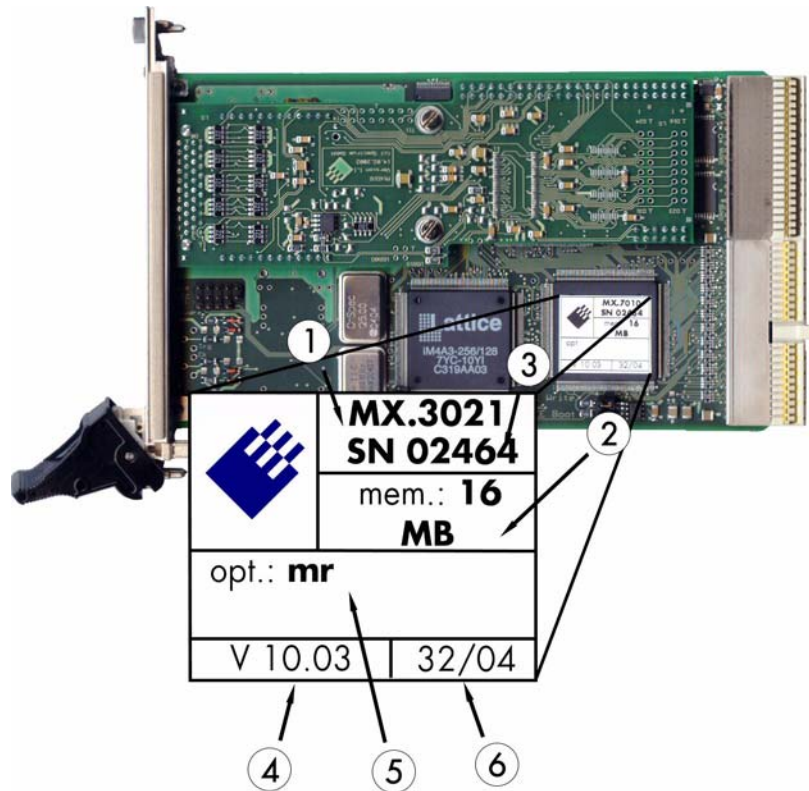

The Spectrum type plate, which consists of the following components, can be found on all of our boards.

- ① The board type, consisting of the two letters describing the bus (in this case MX for the PXI bus) and the model number.
- ② The size of the on-board installed memory in MSamples. In this example there are 8 MS (16 MByte) installed.
- ③ The serial number of your Spectrum board. Every board has a unique serial number.
- ④ The board revision, consisting of the base version and the module version.
- ⑤ A list of the installed options. A complete list of all available options is shown in the order information. In this example the option 'Multiple Recording' is installed.
- ⑥ The date of production, consisting of the calendar week and the year.



Please always supply us with the above information, especially the serial number in case of support request. That allows us to answer your questions as soon as possible. Thank you.

Hardware information

Block diagram

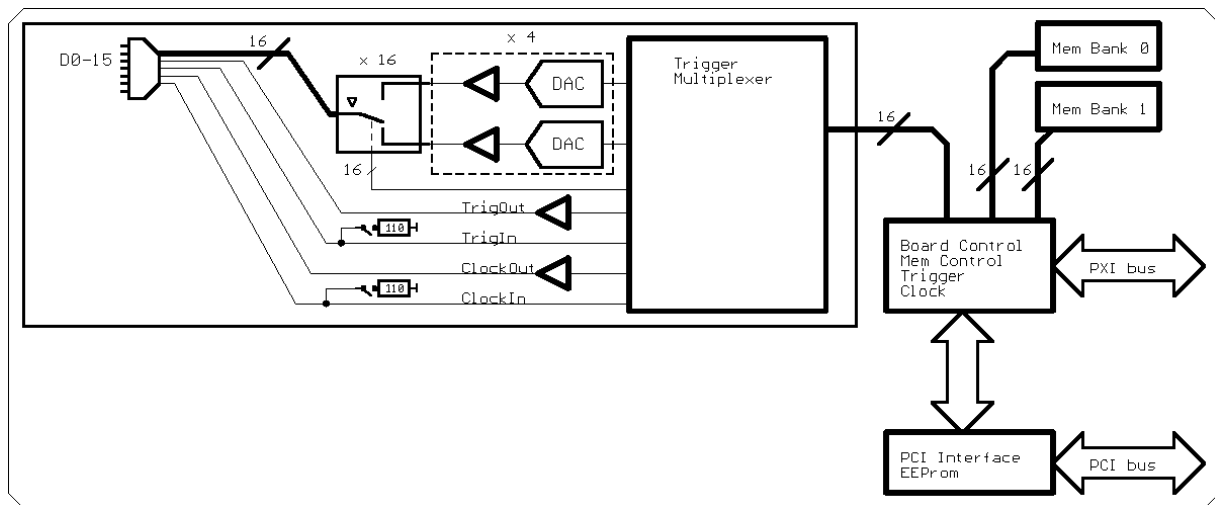

Technical Data

Internal samplerate	1 kS/s up to maximum (depending on model)			Dimension	160 mm x 100 mm (Standard 3U)
External samplerate	DC up to maximum (depending on model)			Width (MX.7210)	1 slot
Clock input impedance	110 Ohm / 50 kOhm 15 pF			Width (MX.7220)	2 slots
Trigger input impedance	110 Ohm / 50 kOhm 15 pF			Output connector	40 pole half pitch (Hirose FX2 series)
Output impedance	approximately 80 Ohm			Power connector (MX.7220 only)	soldered Y - cable with Molex 8981 (5,25" disc drive connector)
Data signal level	programmable from -2.0 V up to +10.0 V with an accuracy of ± 10 mV				
Output swing	0.1 ... 12.0 V				
Maximum output current	per pin	per nibble	per card	Operating temperature	0°C to 50°C
	100 mA	200 mA	0.5 A (MX.7210 only)	Storage temperature	-10°C to 70°C
Rise time ^a	1 MHz	40 MHz		Humidity	10% to 90%
Fall time ^a	2.00 ns	2.25 ns		MTBF	100000 hours
Multi: Trigger to 1st sample delay	fixed				
Multi: Recovery time	< 20 samples (16 - 32 bit)				
Trigger accuracy (samples)	32 bit	16 bit	8 bit		
	1	1	2		

a. Tested with full output swing from -2.0 V to 10.0 V with no load

Trigger input: Standard TTL level	Low: -0.5 V > level < 0.8 V High: 2.0 V > level < 5.5 V Trigger pulse must be valid ≥ 2 clock periods.	Clock input: Standard TTL level	Low: -0.5 V > level < 0.8 V High: 2.0 V > level < 5.5 V Rising edge. Duty cycle: 50% \pm 5%
Trigger output	Standard TTL, capable of driving 50 Ohm. Low < 0.4 V (@ 20 mA, max 64 mA) High > 2.4 V (@ -20 mA, max -48 mA) One positive edge after the first internal trigger	Clock output	Standard TTL, capable of driving 50 Ohm Low < 0.4 V (@ 20 mA, max 64 mA) High > 2.4 V (@ -20 mA, max -48 mA)

Power consumption (maximum value)	Full speed			
	+3.3 V (PXI Bus)	+5 V (PXI Bus)	+12 V (PXI Bus)	+12 V (Connector)
MX.7210 (16 bit output @ 10 MS/s) ^a	0.76 A (2.5 W)	0.5 A (2.5 W)	0.35 A (4.2 W)	-
MX.7220 (16 bit output @ 40 MS/s) ^b	0.91 A (3.0 W)	0.6 A (3.0 W)	0 A	1.8 A (21.6 W)

a. Tested with full output swing from -2.0 to 10.0 V with no load

b. Tested with full output swing from -2.0 V to 10.0 V with 50 mA output current per pin

Order information

Order No	Description	Order No	Description
MX7210	MX.7210 with 16 MByte (128 MBit) memory, cables and drivers	MX7xxx-32M	Option: 32 MByte memory instead of 16 MByte standard mem
MX7220	MX.7220 with 16 MByte (128 MBit) memory, cables and drivers	MX7xxx-64M	Option: 64 MByte memory instead of 16 MByte standard mem
MX7xxx-mr	Option Multiple Replay: Memory segmentation	MX7xxx-128M	Option: 128 MByte memory instead of 16 MByte standard mem
MX7xxx-gs	Option Gated Replay: Gate signal controls acquisition/replay	MX7xxx-up	Additional handling cost for later memory upgrade
Cab-d40-idc-100	Additional 1m 40 pole flat ribbon cable with IDC socket connector	MX72xx-dl	DASyLab driver for MX.72xx series
Cab-d40-d40-100	Additional 1m 40 pole flat ribbon cable withFx2 connector	MX72xx-hp	VEE driver for MX.72xx series
		MX72xx-lv	LabVIEW driver for MX.72xx series
		MATLAB	MATLAB driver for all MI.xxxx, MC.xxxx and MX.xxxx series.

Hardware Installation

System Requirements

All Spectrum MX.xxxx instrumentation boards are compliant to the PXI 3U standard and require in general one free slot. Depending on the installed options additional free slots can be necessary.

Warnings

ESD Precautions

The boards of the MX.xxxx series contain electronic components that can be damaged by electrostatic discharge (ESD).

Before installing the board in your system or even before touching it, it is absolutely necessary to bleed of any electrostatic electricity.

Cooling Precautions

The boards of the MX.xxxx series operate with components having very high power consumption at high speeds. For this reason it is absolutely required to cool this board sufficiently. It is strongly recommended to install an additional cooling fan producing a stream of air across the boards surface. In most cases PXI systems are already equipped with sufficient cooling power. In that case please make sure that the air stream is not blocked.

During longer pauses between the single measurements the power down mode should be called to reduce the heat production.

Sources of noise

The boards of the MX.xxxx series should be placed far away from any noise producing source (like e.g. the power supply). It should especially be avoided to place the board in the slot directly adjacent to another fast board (like the graphics controller).

Installing the board in the system

Installing a single board without any options

The locks on the bottom side of PXI boards need to be unlocked and opened before installing the board into a free slot of the system. Therefore you need to press the little button on the inside of the fastener and move it outwards (see figure). Now slowly insert the card into the host system using the key ways until the lock snaps in with a „click“.

While inserting the board take care not to tilt it.



After the board's insertion fasten the two screws carefully, without overdoing.

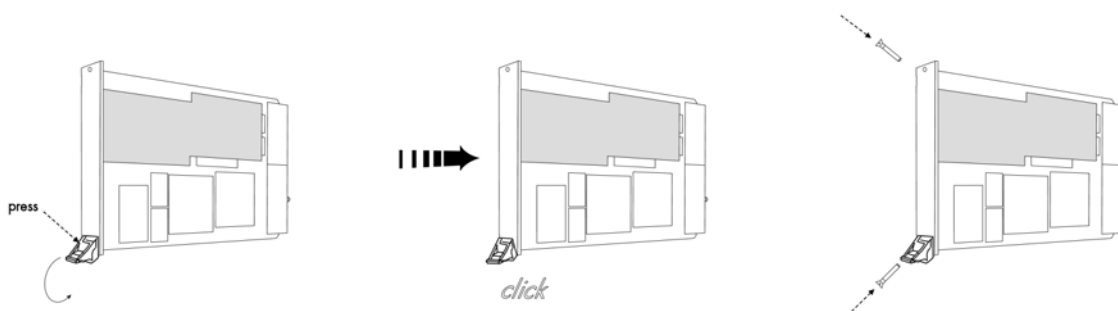

Installing a single MX.7220 board without any options

As the MX.7220 board requires the width of two slots you first need to unscrew and remove the dedicated blind-brackets usually mounted to cover unused slots of your PXI system before installing the board and the included ventilation bracket. The locks on the bottom side of both PXI brackets need to be unlocked and opened before installing the board into a free slot of the system. Therefore you need to press the little buttons on the inside of the fasteners and move them outwards (see figure). Now slowly insert the card into the host system using the key ways until both locks snap in with a „click“.



While inserting the board take care not to tilt it.

After the board's insertion the board needs to be connected to the power supply by its own power cable. The cable is assembled as a Y-cable to enable to connect further MX.7220 boards or other PC devices. As long as there are unused cables on your PC power supply we recommend to use a separate cable for every MX.7220 board. After the board's insertion fasten the screws of both brackets carefully, without overdoing.

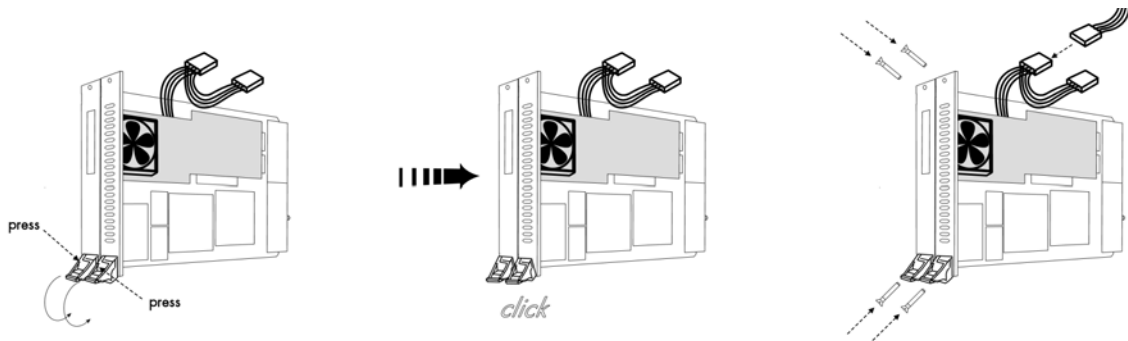

Software Driver Installation

Before using the board a driver must be installed that matches the operating system. The installation is done in different ways depending on the used operating system. The driver that is on CD supports all boards of the MI, MC and MX series. That means that you can use the same driver for all boards of these families.

Interrupt Sharing

This board uses a PCI interrupt for DMA data transfer and for controlling the FIFO mode. The used interrupt line is allocated by the PC BIOS at system start and is normally depending on the selected slot. Because there is only a limited number of interrupt lines available on the PCI bus it can happen that two or more boards must use the same interrupt line. This so called interrupt sharing must be supported by all drivers of the participating equipment.

Most available drivers and also the Spectrum driver for your board can manage interrupt sharing. But there are also some drivers on the market that can only use one interrupt exclusively. If this equipment shares an interrupt with the Spectrum board, the system will hang up if the second driver is loaded (the time is depending on the operating system).

If this happens it is necessary to reconfigure the system in that way that the critical equipment has an exclusive access to an interrupt.

On most systems the BIOS shows a list of all installed PCI boards with their allocated interrupt lines directly after system start. You have to check whether an interrupt line is shared between two boards. Some BIOS allow the manual allocation of interrupt lines. Have a look in your mainboard manual for further information on this topic.

Because normally the interrupt line is fixed for one PCI slot it is simply necessary to use another slot for the critical board to force a new interrupt allocation. You have to search a configuration where all critical boards have only exclusive access to one interrupt.

Depending on the system, using the Spectrum board with a shared interrupt may degrade performance a little. Each interrupt needs to be checked by two drivers. For this reason when using time critical FIFO mode even the Spectrum board should have an exclusively access to one interrupt line.

Important Notes on Driver Version 4.00

With Windows driver version V4.00 and later the support for Windows 64 bit versions was added for MI, MC and MX series cards. This required an internal change such that Windows 98, Windows ME, and Windows 2000 versions are no longer compatible with the WDM driver version.

Windows 98 and Windows ME should use the latest 3.39 driver version (delivered on CD revision 3.06), because with driver version V4.00 on these two operating systems are no longer supported.



Windows 2000 users can alternatively change from the existing WDM driver to the Windows NT legacy driver, which is still supported by Spectrum.

Because changing from one driver model (WDM) to another (NT legacy) might result in conflicts please contact Spectrum prior to the update.



Windows XP 32/64 Bit

Installation

When installing the board in a Windows XP system the Spectrum board will be recognized automatically on the next start-up.

The system offers the direct installation of a driver for the board.

Do not let Windows automatically search for the best driver, because sometimes the driver will not be found on the CD. Please take the option of choosing a manual installation path instead.



Allow Windows XP to search for the most suitable driver in a specific directory. Select the CD that was delivered with the board as installation source. The driver files are located on CD in the directory

\Driver\win32\winxp_vista_7 for Windows Vista/7 (for 32 Bit)

or

\Driver\win64\winxp_vista_7 for Windows Vista/7 (for 64 Bit)

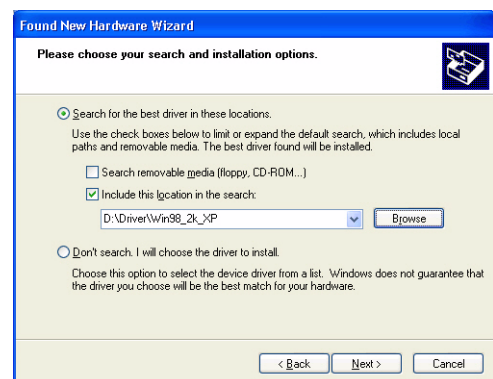

The hardware assistant shows you the exact board type that has been found like the Ml.3020 in the example. Older boards (before June 2004) show „Spectrum Board“ instead.

The drivers can be used directly after installation. It is not necessary to restart the system. The installed drivers are linked in the device manager.

Below you'll see how to examine the driver version and how to update the driver with a newer version.

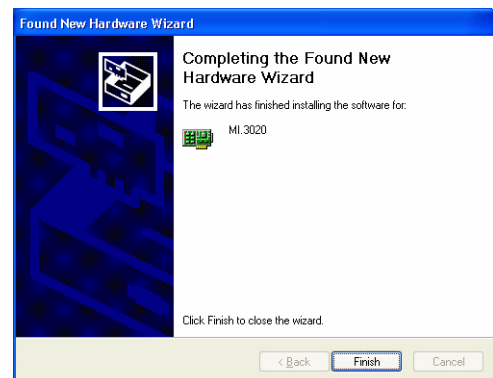

Version control

If you want to check which driver version is installed in the system this can be easily done in the device manager. Therefore please start the device manager from the control panel and show the properties of the installed driver.

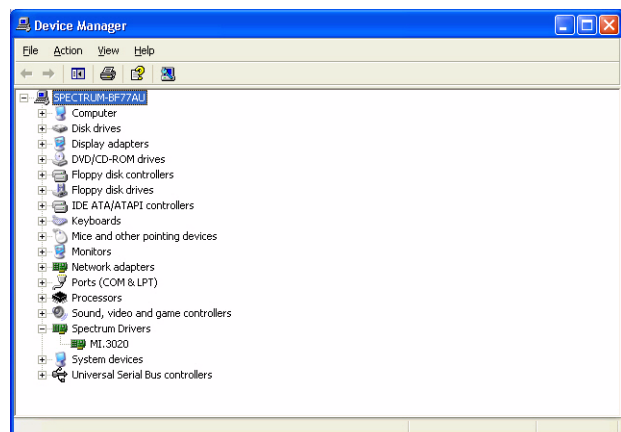

On the property page Windows XP shows the date and the version of the installed driver.

After clicking the driver details button the detailed version information of the driver is shown. In the case of a support question this information must be presented together with the board's serial number to the support team to help finding a fast solution.

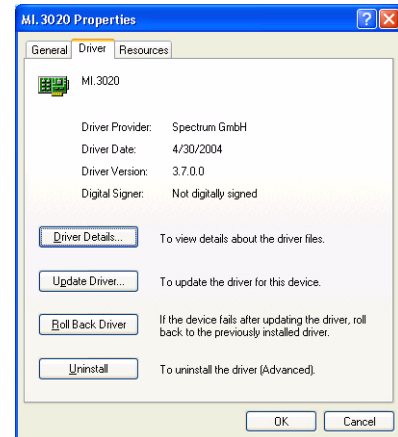

Driver - Update

If a new driver version should be installed no Spectrum board is allowed to be in use by any software. So please stop and exit all software that could access the boards.

A new driver version is directly installed from the device manager. Therefore please open the properties page of the driver as shown in the section before. As next step click on the update driver button and follow the steps of the driver installation in a similar way to the previous board and driver installation.

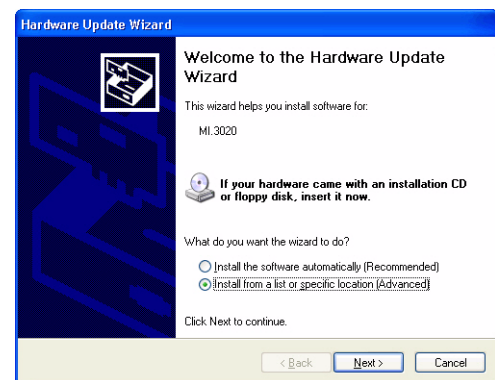

Please select the path where the new driver version was unzipped to. If you've got the new driver version on CD please select the proper path on the CD containing the new driver version:

\Driver\win32\winxp_vista_7 for Windows Vista/7 (for 32 Bit)

or

\Driver\win64\winxp_vista_7 for Windows Vista/7 (for 64 Bit)

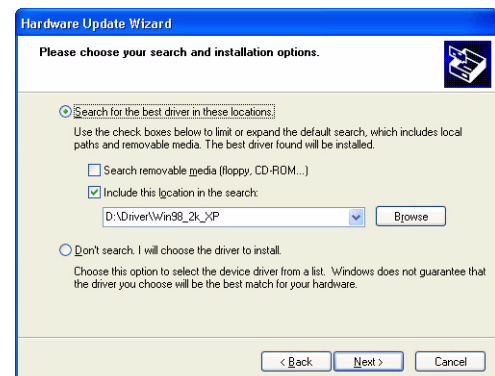

The new driver version can be used directly after installation without restarting the system. Please keep in mind to update the driver of all installed Spectrum boards.

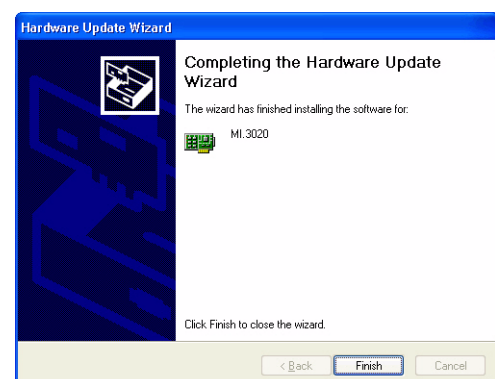

Windows Vista/7 32/64 Bit

Installation

When installing the card in a Windows Vista or Windows 7 system, it might be recognized automatically on the next start-up. The system tries at first to automatically search and install the drivers from the Microsoft homepage.

This mechanism will fail at first for the „PCI Device“ device, because the Spectrum drivers are not available via Microsoft, so simply close the dialog. This message can be safely ignored.

Afterwards open the device manager from the Windows control panel, as shown on the right.

Find the above mentioned „PCI Device“, right-click and select „Update Driver Software...“

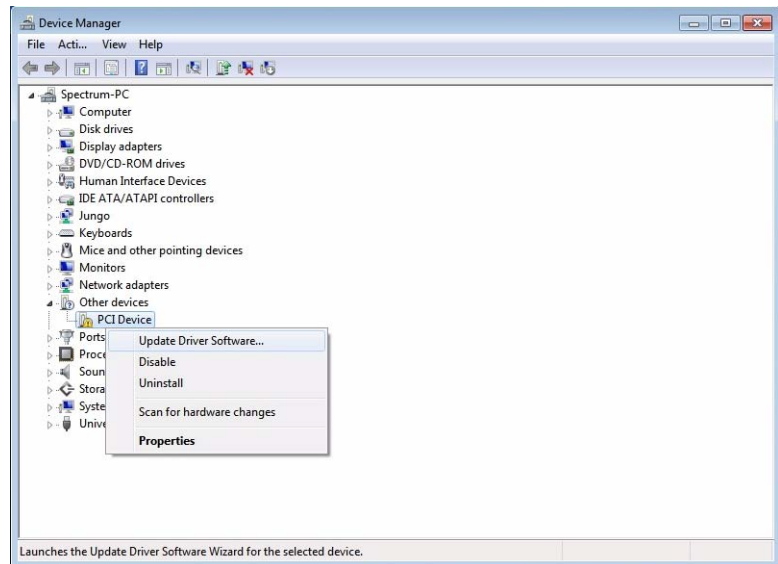

Do not let Windows Vista/7 automatically search for the best driver, because it will search the internet and not find a proper driver. Please take the option of browsing the computer manually for the driver software instead. Allow Windows Vista/7 to search for the most suitable driver in a specific directory.

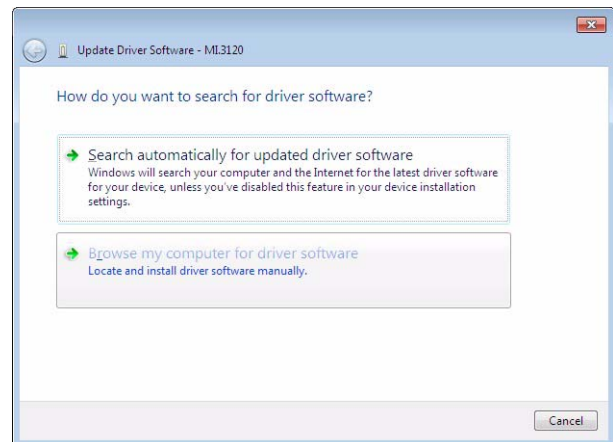

Now simply select the root folder of the CD that was delivered with the board as installation source and enable the „Include subfolders“ option.

Alternatively you can browse to the installations folders. The driver files are located on CD in the directory
 \Driver\win32\winxp_vista_7 for Windows Vista/7 (for 32 Bit)
 or
 \Driver\win64\winxp_vista_7 for Windows Vista/7 (for 64 Bit)

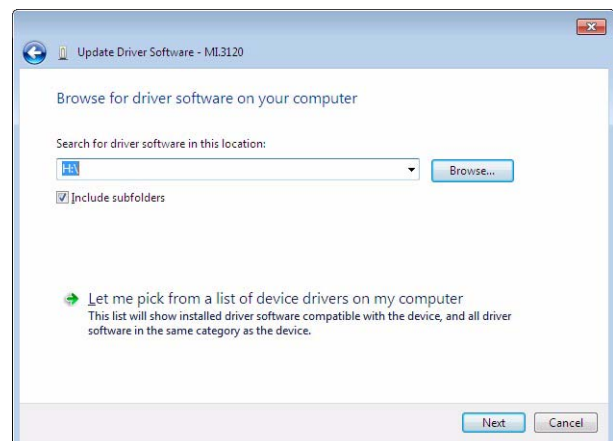

On the upcoming Windows security dialog select install. To prevent Windows Vista/7 to always ask this question for future updates, you can optionally select to always trust software from Sptcrum.

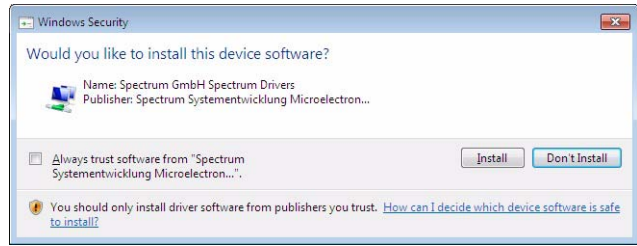

The hardware assistant then shows you the exact board type that has been found like the MI.3120 in the example.

The drivers can be used directly after installation. It is not necessary to restart the system. The installed drivers are linked in the device manager.

Below you'll see how to examine the driver version and how to update the driver with a newer version.

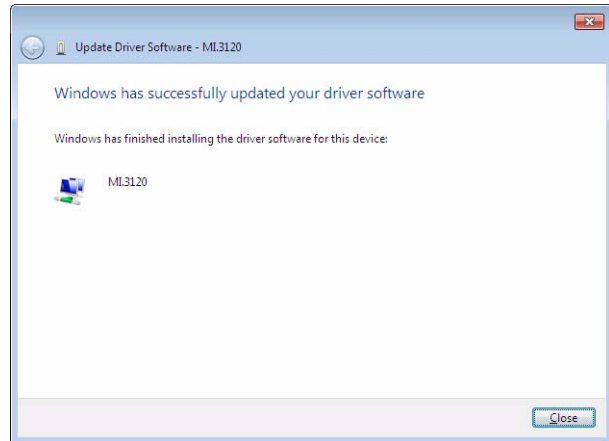

Version control

If you want to check which driver version is installed in the system this can be easily done in the device manager. Therefore please start the device manager from the control panel and show the properties of the installed driver.

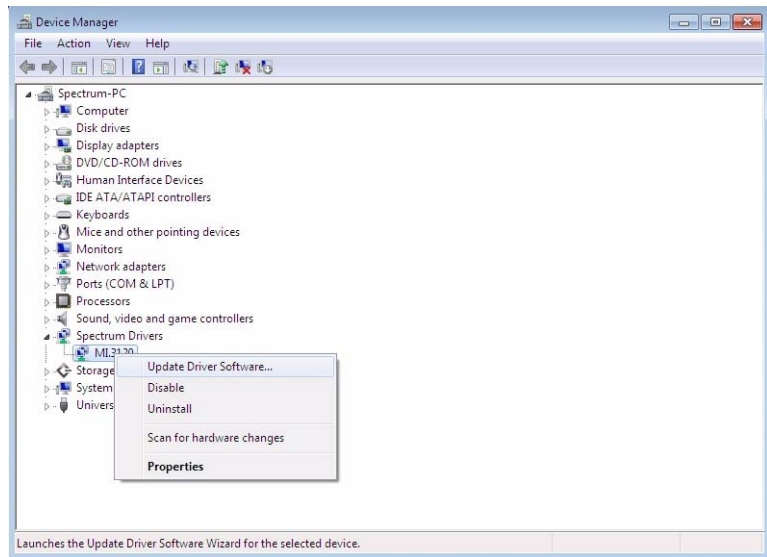

On the property page Windows Vista/7 shows the date and the version of the installed driver.

After clicking the driver details button the detailed version information of the driver is shown. In the case of a support question this information must be presented together with the board's serial number to the support team to help finding a fast solution.

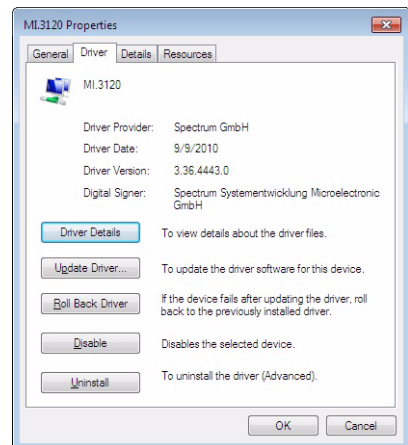

Driver - Update

The driver update under Windows Vista/7 is exact the same procedure as the initial installation. Please follow the steps above, starting from the device manager, select the Spectrum card to be updated, right-click and select „Update Driver Software..." and follow the steps above.

Windows NT / Windows 2000 32 Bit

Installation



Under Windows NT and Windows 2000 the Spectrum driver must be installed manually. The driver is found on CD in the directory \Driver\win32\winnt.

Please start the „winNTDrv_Install.exe“ program. The installation is performed totally automatically, simply click on the „Next“ button. After installation the system must be rebooted once (see picture on the right

side). The driver is install to support one PCI/PXI or CompactPCI device. If more boards are installed in the system the configuration of the driver has to be changed. Please see the following chapter for this topic.

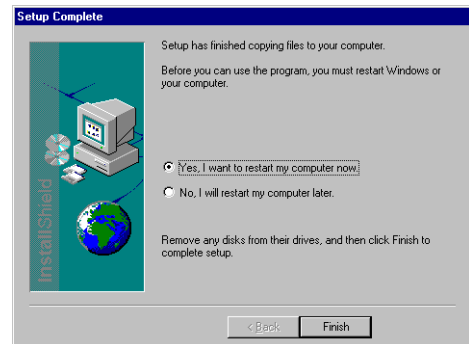

Adding boards to the Windows NT / Windows 2000 driver

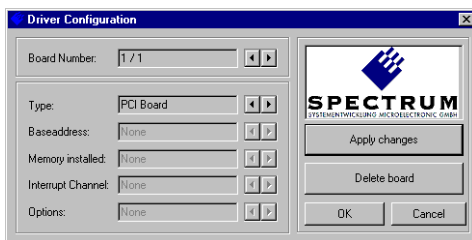

The Windows NT legacy driver must be configured by the Driver Configuration utility to support more than one board. The Driver Configuration utility is automatically installed with the driver. The Utility can be found in the start menu as „DrvConfig“.



To add a new card please follow these steps:

- Increase the board number on top of the screen by pressing the right button
- Change the board type from „Not Installed“ to „PCI Board“
- Press the „Apply changes“ button
- Press the „OK“ button
- Restart the system

Driver - Update

If a new driver version should be installed no Spectrum board is allowed to be in use by any software. So please stop and exit all software that could access the boards.

When updating a system please simply execute the setup file of the new driver version. Afterwards the system has to be rebooted. The driver configuration is not changed.

Important Notes on Driver Version 4.00

With Windows driver version V4.00 and later the support for Windows 64 bit versions was added for MI, MC and MX series cards. This required an internal change such that Windows 98, Windows ME, and Windows 2000 versions are no longer compatible with the WDM driver version.



Because changing from one driver model (WDM) to another (NT legacy) might result in conflicts please contact Spectrum prior to the update.

Linux

Overview

The Spectrum boards are delivered with drivers for linux. It is necessary to install them manually following the steps explained afterwards. The linux drivers can be found on CD in the directory /Driver/linux. As linux is an open source operating system there are several distributions in use world-wide that are compiled with different kernel settings. As we are not able to install and maintain hundreds of different distributions and versions we had to focus on some common used linux distributions.

However if your distribution does not work with one of these pre-compiled kernel modules or you have a specialized kernel installed (like a SMP kernel) you can get the linux driver sources directly from us. With this sources it's no problem to compile and use the linux driver on your system. Please contact your local distributor to get the sources. The Spectrum linux drivers are compatible with kernel versions 2.4 and 2.6.

On this CD you'll find pre-compiled linux kernel modules for the following versions

Distribution	Kernel Version	Processor	Width	Distribution	Kernel Version	Processor	Width
Suse 9.0	2.4.21	single only	32 bit	Redhat 9.0	2.4.20	single and smp	32 bit
Suse 9.1	2.6.4	single and smp	32 bit	Fedora Core 3	2.6.9	single and smp	32 bit
Suse 9.3	2.6.11	single and smp	32 bit	Fedora Core 4	2.6.11	single and smp	32 bit
Suse 10.0	2.6.13	single only	32 bit and 64 bit	Fedora Core 5	2.6.15	single and smp	32 bit and 64 bit
Suse 10.1	2.6.16	single only	32 bit and 64 bit	Fedora Core 6	2.6.18	single and smp	32 bit and 64 bit
Suse 10.2	2.6.18	single and smp	32 bit and 64 bit	Fedora Core 7	2.6.21	single and smp	32 bit and 64 bit
Suse 10.3	2.6.22	single and smp	32 bit and 64 bit	Fedora 8	2.6.23	single and smp	32 bit and 64 bit
Suse 11.0	2.6.25	single and smp	32 bit and 64 bit	Fedora 9	2.6.25	single and smp	32 bit and 64 bit
Suse 11.1	2.6.27	single and smp	32 bit and 64 bit	Fedora 10	2.6.27	single and smp	32 bit and 64 bit
Suse 11.2	2.6.31	single and smp	32 bit and 64 bit	Fedora 11	2.6.29	single and smp	32 bit and 64 bit
Suse 11.3	2.6.34	single and smp	32 bit and 64 bit	Fedora 12	2.6.31	single and smp	32 bit and 64 bit
Suse 11.4	2.6.38	single and smp	32 bit and 64 bit	Fedora 13	2.6.33.3	single and smp	32 bit and 64 bit
Suse 12.1	3.1	single and smp	32 bit and 64 bit	Fedora 14	2.6.35.6	single and smp	32 bit and 64 bit
				Fedora 15	2.6.38.6	single and smp	32 bit and 64 bit
Debian Sarge	2.4.27	single	32 bit	Fedora 16	3.1	single and smp	32 bit and 64 bit
Debian Etch	2.6.18	single and smp	32 bit and 64 bit	Debian Sarge	2.6.8	single	32 bit
				Debian Lenny	2.6.26	single and smp	32 bit and 64 bit

64 bit

The Spectrum Linux Drivers also run under 64 bit systems based on the AMD 64 bit architecture (AMD64). The Intel architecture (IA64) is not supported and has not been tested. All drivers, examples and programs need to be recompiled to run under 64 bit Linux. The 64 bit support is available starting with driver version 3.18. Due to the different pointer size two additional functions have been implemented that are described later on. All special functionality concerning 64 bit Linux support is marked with the logo seen on the right.



Installation

Login as root.

It is necessary to have the root rights for installing a driver.

Select the right driver from the CD.

Refer to the list shown above. If your distribution is not listed there please select the module that most closely matches your installed kernel version. Copy the driver kernel module spc.o from the CD directory to your hard disk. Be sure to use a hard disk directory that is accessible by all users who should work with the board.

First time load of the driver

The linux driver is shipped as the loadable module spc.o. The driver includes all Spectrum PCI, PXI and CompactPCI boards. The boards are recognized automatically after driver loading. Load the driver with the insmod command:

```
linux:~ # insmod spc.o
```

The insmod command may generate a warning that the driver module was compiled for another kernel version. In that case you may try to load the driver module with the force parameter and test the board very carefully.

```
linux:~ # insmod -f spc.o
```

If the kernel module could not be loaded in your linux installation it is necessary to compile the driver directly on your system. Please contact Spectrum to get the needed source files including the compilation description.

Depending on the used linux distribution the insmod command generates a message telling the driver version and the board types and serial numbers that have been found. If your distribution does not show this message it is possible to view them with the dmesg command:

```
linux:~ # dmesg
... some other stuff
spc driver version: 3.07 build 0
sp0: MI.3020 sn 01234
```

In the example we show you the output generated by a MI.3020. All other board types are similar to this output but showing the correct board type.

Udev support

Starting with driver version 3.21 build 1548 the driver natively supports udev. Once the driver is loaded it automatically generates the device nodes under /dev. The cards are automatically named to /dev/spc0, /dev/spc1, ... If udev is installed on your system the following two installation steps are not necessary to be made manually. You may use all the standard naming and rules that are available with udev.

Examine the major number of the driver

For accessing the device driver it is necessary to know the major number of the device. This number is listed in the /proc/devices list. The device driver is called "spec" in this list. Normally this number is 254 but this depends on the device drivers that have been installed before.

```
linux:~ # cat /proc/devices
Character devices:
...
171 ieee1394
180 usb
188 ttyUSB
254 spec

Block devices:
 1 ramdisk
 2 fd
...
```

Installing the device

You connect a device to the driver with the mknod command. The major number is the number of the driver as shown in the last step, the minor number is the index of the board starting with 0. This step must only be done once for the system where the boards are installed in. The device will remain in the file structure even if the board is de-installed from the system.

The following command makes a device for the first Spectrum board the driver has found:

```
linux:~ # mknod /dev/spc0 c 254 0
```

Make sure that the users who work with the driver have full rights access for the device. Therefore you should give all persons all rights to the device:

```
linux:~ # chmod a+w /dev/spc0
```

Now it is possible to access the board using this device.

Driver info

Information about the installed boards could be found in the /proc/spectrum file. All PCI, PXI and CompactPCI boards show the basic information found in the EEPROM there. This is an example output generated by a MI.3020:

```
linux:~ # cat /proc/spectrum

Spectrum driver information
-----
Driver Version: 3.07 build 0

Board#0: MI.3020
  serial number:    01234
  production month: 05/2004
  version:         9.6
  samplerate:      100 MHz
  installed memory: 16 MBytes
```

Automatic load of the driver

It is necessary to load the kernel driver module after each start of the system before using the boards. Therefore you may add the „insmod spc.o“ command in one of the start-up files. Or you may load the kernel driver module manually whenever you need access to the board.

Software

This chapter gives you an overview about the structure of the drivers and the software, where to find and how to use the examples. It detailed shows how the drivers are included under different programming languages and where the differences are when calling the driver functions from different programming languages.

This manual only shows the use of the standard driver API. For further information on programming drivers for third-party software like LabVIEW, MATLAB, DASYLab or VEE an additional manual is required that is delivered with the ordered driver option.



Software Overview

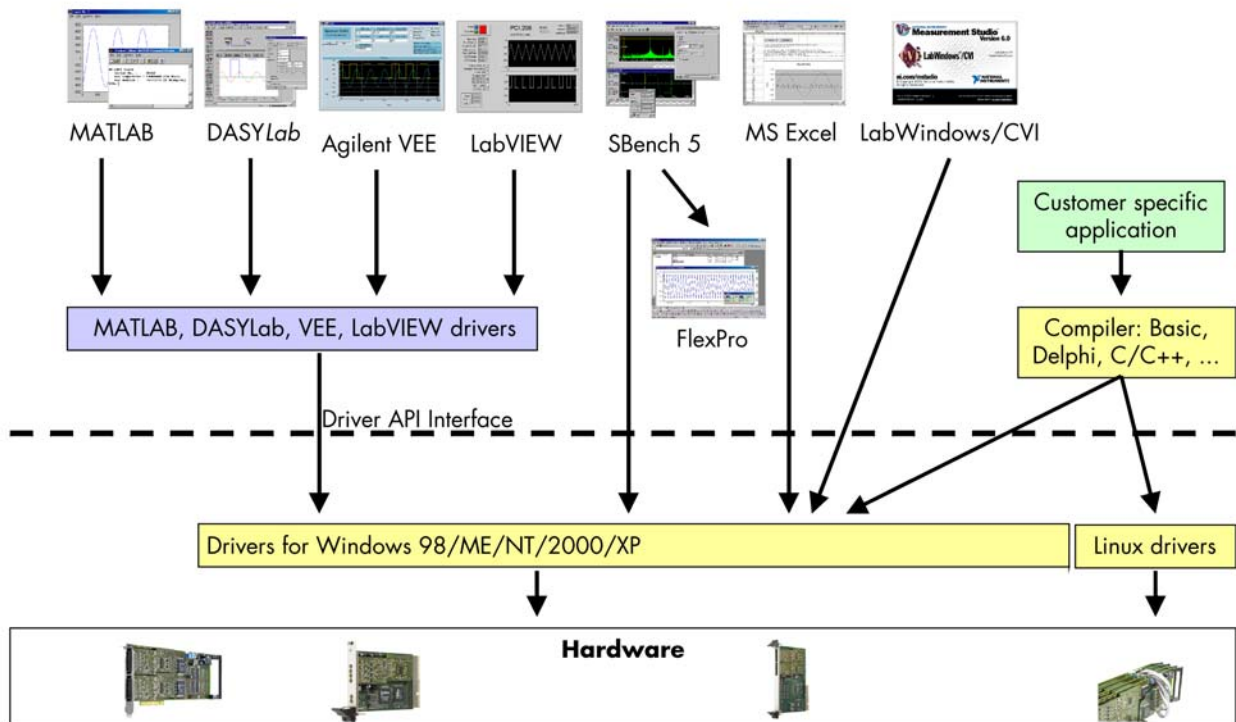

The Spectrum drivers offer you a common and fast API for using all of the board hardware features. This API is nearly the same on all operating systems. Based on this API one can write your own programs using any programming language that can access the driver API. This manual detailed describes the driver API allowing you to write your own programs.

The optional drivers for third-party products like LabVIEW or DASYLab are also based on this API. The special functionality of these drivers is not subject of this manual and is described on separate manuals delivered with the driver option.

C/C++ Driver Interface

C/C++ is the main programming language for which the drivers have been build up. Therefore the interface to C/C++ is the best match. All the small examples of the manual showing different parts of the hardware programming are done with C.



Header files

The basic task before using the driver is to include the header files that are delivered on CD together with the board. The header files are found in the directory /Driver/header_c. Please don't change them in any way because they are updated with each new driver version to include the new registers and new functionality.

dlltyp.h	Includes the platform specific definitions for data types and function declarations. All data types are based on this definitions. The use of this typ definition file allows the use of examples and programs on different platforms without changes to the program source.
regs.h	Defines all registers and commands which are used in the Spectrum driver for the different boards. The registers a board uses are described in the board specific part of the documentation.
spectrum.h	Defines the functions of the driver. All definitions are taken from the file dlltyp.h. The functions itself are described below.
spcerr.h	Lists all and describes all error codes that can be given back by any of the driver functions. The error codes and their meaning are described in detail in the appendix of this manual.
errors.h	Only there for backward compatibility with older program versions. Please use spcerr.h instead.

Example for including the header files:

```
// ----- driver includes -----
#include "../c_header/dlltyp.h"
#include "../c_header/spectrum.h"
#include "../c_header/spcerr.h"
#include "../c_header/regs.h"
```

Microsoft Visual C++

Include Driver

The driver files can be easily included in Microsoft C++ by simply using the library file that is delivered together with the drivers. The library file can be found on the CD in the path /Examples/vc/c_header. Please include the library file Spectrum.lib in your Visual C++ project. All functions described below are now available in your program.

Examples

Examples can be found on CD in the path /Examples/vc. There is one subdirectory for each board family. You'll find board specific examples for that family there. The examples are bus type independent. As a result that means that the MI30xx directory contains examples for the MI.30xx, the MC.30xx and the MX.30xx families. The example directories contain a running project file for Microsoft Visual C++ that can be directly loaded and compiled.

There are also some more board independent examples in the directory MIxxxx. These examples show different aspects of the boards like programming options or synchronization and have to be combined with one of the board specific example.

Borland C++ Builder

Include Driver

The driver files can be easily included in Borland C++ Builder by simply using the library file that is delivered together with the drivers. The library file can be found on the CD in the path /Examples/vc/c_header. Please include the library file spclib_bcc.lib in your Borland C++ Builder project. All functions described below are now available in your program.

Examples

The Borland C++ Builder examples share the sources with the Visual C++ examples. Please see above chapter for a more detailed documentation of the examples. In each example directory are project files for Visual C++ as well as Borland C++ Builder.

Linux Gnu C

Include Driver

The interface of the linux drivers is a little bit different from the windows interface. To make the access easier and to have more similar examples we added an include file that re maps the standard driver functions to the linux specific functions. This include file is found in the path /Examples/linux/spcioctl.inc. All examples are based on this file.

Example for including Linux driver:

```
// ----- driver includes -----
#include "../c_header/dlltyp.h"
#include "../c_header/regs.h"
#include "../c_header/spcerr.h"

// ----- include the easy ioctl commands from the driver -----
#include "../c_header/spcioctl.inc"
```

Examples

Examples can be found on CD in the path /Examples/linux. There is one subdirectory for each board family. You'll find board specific examples for that family there. The examples are bus type independent. As a result that means that the MI30xx directory contains examples for the MI.30xx, the MC.30xx and the MX.30xx families. The examples are simple one file programs and can be compiled using the Gnu C compiler gcc. It's not necessary to use a makefile for them.

Other Windows C/C++ compilers

Include Driver

To access the driver, the driver functions must be loaded from the driver dll. This can be easily done by standard windows functions. There is one example in the directory /Examples/other that shows the process. After loading the functions from the dll one can proceed with the examples that are given for Microsoft Visual C++.

Example of function loading:

```
// definition of external function that has to be loaded from DLL
typedef int16 (SPCINITPCIBOARDS) (int16* pnCount, int16* pnPCIVersion);
typedef int16 (SPCSETPARAM) (int16 nNr, int32 lReg, int32 lValue);
typedef int16 (SPCGETPARAM) (int16 nNr, int32 lReg, int32* plValue);
...
SPCINITPCIBOARDS* pfnSpcInitPCIBoards;
SPCSETPARAM* pfnSpcSetParam;
SPCGETPARAM* pfnSpcGetParam;
...
// ----- Search for dll -----
hDLL = LoadLibrary ("spectrum.dll");

// ----- Load functions from DLL -----
pfnSpcInitPCIBoards = (SPCINITPCIBOARDS*) GetProcAddress (hDLL, "SpcInitPCIBoards");
pfnSpcSetParam = (SPCSETPARAM*) GetProcAddress (hDLL, "SpcSetParam");
pfnSpcGetParam = (SPCGETPARAM*) GetProcAddress (hDLL, "SpcGetParam");
```

National Instruments LabWindows/CVI

Include Drivers

To use the Spectrum driver under LabWindows/CVI it is necessary to first load the functions from the driver dll. This is more or less similar to the above shown process with the only difference that LabWindows/CVI uses it's own library handling functions instead of the windows standard functions.

Example of function loading under LabWindows/CVI:

```
// ----- load the driver entries from the DLL -----
DriverId = LoadExternalModule ("spectrum.lib");

// ----- Load functions from DLL -----
SpcInitPCIBoards = (SPCINITPCIBOARDS*) GetExternalModuleAddr (DriverId, "SpcInitPCIBoards", &Status);
SpcSetParam = (SPCSETPARAM*) GetExternalModuleAddr (DriverId, "SpcSetParam", &Status);
SpcGetParam = (SPCGETPARAM*) GetExternalModuleAddr (DriverId, "SpcGetParam", &Status);
```

Examples

Examples for LabWindows/CVI can be found on CD in the directory /Examples/cvi. These examples show mainly how to include the driver in a LabWindows/CVI environment and don't use any special functions of the boards. The examples have to be merged with the standard windows examples described under Visual C++.

Driver functions

The driver contains five functions to access the hardware.

Function SpcInitPCIBoard

This function initializes all installed PCI, PXI and CompactPCI boards. The boards are recognized automatically. All installation parameters are read out from the hardware and stored in the driver. The number of PCI boards will be given back in the value Count and the version of the PCI bus itself will be given back in the value PCIVersion.

Function SpcInitPCIBoards:

```
int16 SpcInitPCIBoards (int16* count, int16* PCIVersion);
```

Under Linux this function is not available. Instead one must open and close the driver with the standard file functions open and close. The functionality behind this function is the same as the SpcInitPCIBoards function.



Using the Driver under Linux:

```
hDrv = open ("/dev/spc0", O_RDWR);
...
close (hDrv);
```

Function SpcSetParam

All hardware settings are based on software registers that can be set by the function SpcSetParam. This function sets a register to a defined value or executes a command. The board must first be initialized. The available software registers for the driver are listed in the board specific part of the documentation below.

The value „nr“ contains the index of the board that you want to access, the value „reg“ is the register that has to be changed and the value „value“ is the new value that should be set to this software register. The function will return an error value in case of malfunction.

Function SpcSetParam

```
int16 SpcSetParam (int16 nr, int32 reg, int32 value);
```



Under Linux the value „nr“ must contain the handle that was retrieved by the open function for that specific board. The value is then not of the type „int16“ but of the type „handle“.

Function SpcGetParam

The function SpcGetParam reads out software registers or status information. The board must first be initialized. The available software registers for the driver are listed in the board specific part of the documentation below.

The value „nr“ contains the index of the board that you want to access, the value „reg“ is the register that has to be read out and the value „value“ is a pointer to a value that should contain the read parameter after function call. The function will return an error value in case of malfunction.

Function SpcGetParam

```
int16 SpcGetParam (int16 nr, int32 reg, int32* value);
```



Under Linux the value „nr“ must contain the handle that was given back by the open function of that specific board. The value is then not of the type „int16“ but of the type „handle“.

Function SpcSetAdr

This function is only available under Linux. It is intended to program one of the FIFO buffer addresses to the driver. Depending on the platform (32 bit or 64 bit) the address parameter has a matching pointer size of 32 bit or 64 bit. This function can be used with Linux 32 bit as well as Linux 64 bit installations. The function was implemented with driver version 3.18 and is not available with prior driver versions. Please be sure to use the matching spcioctl.inc file including this function declaration.

**Linux
64 Bit**

Function SpcSetAdr

```
int16 SpcSetParam (drv_handle hDrv, int32 lReg, void* pvAdr);
```

Function SpcGetAdr

This function is only available under Linux. It is intended to read out one of the FIFO buffer addresses from the driver. Depending on the platform (32 bit or 64 bit) the address parameter has a matching pointer size of 32 bit or 64 bit. This function can be used with Linux 32 bit as well as Linux 64 bit installations. The function was implemented with driver version 3.18 and is not available with prior driver versions. Please be sure to use the matching spcioctl.inc file including this function declaration.

**Linux
64 Bit**

Function SpcGetAdr

```
int16 SpcGetAdr (drv_handle hDrv, int32 lReg, void** ppvAdr);
```

Function SpcSetData

Writes data to the board for a specific memory channel. The board must first be initialized. The value „nr“ contains the index of the board that you want to access, the „ch“ parameter contains the memory channel. „start“ and „len“ define the position of data to be written. „data“ is a pointer to the array holding the data. The function will return an error value in case of malfunction.



This function is only available on generator or i/o boards. The function is not available on acquisition boards.

Function SpcSetData (Windows)

```
int16 SpcSetData (int16 nr, int16 ch, int32 start, int32 len, dataptr data);
```

Under Linux the additional parameter nBytesPerSample must be used for this function. For all boards with 8 bit resolution the parameter is „1“, for all boards with 12, 14 or 16 bit resolution this parameter has to be „2“. Under Linux the value „hDrv“ must contain the handle that was given back by the open function of that specific board. Under Linux the return value is not an error code but the number of bytes that has been written.

Function SpcSetData (Linux)

```
int32 SpcSetData (int hDrv, int32 lCh, int32 lStart, int32 lLen, int16 nBytesPerSample, dataptr pvData)
```

Function SpcGetData

Reads data from the board from a specific memory channel. The board must first be initialized. The value „nr“ contains the index of the board that you want to access, the „ch“ parameter contains the memory channel. „start“ and „len“ define the position of data to be read. „data“ is a pointer to the array that should hold the data. The function will return an error value in case of malfunction.

This function is only available on acquisition or i/o boards. The function is not available on generator boards.



Function SpcGetData

```
int16 SpcGetData (int16 nr, int16 ch, int32 start, int32 len, dataptr data);
```

Under Linux the additional parameter nBytesPerSample must be used for this function. For all boards with 8 bit resolution the parameter is „1“, for all boards with 12, 14 or 16 bit resolution this parameter has to be „2“, when reading timestamps this parameter has to be „8“. Under Linux the value „hDrv“ must contain the handle that was given back by the open function of that specific board. Under Linux the return value is not an error code but is the number of bytes that has been read.

Function SpcGetData (Linux)

```
int32 SpcGetData (int hDrv, int32 lCh, int32 lStart, int32 lLen, int16 nBytesPerSample, dataptr pvData)
```

Delphi (Pascal) Programming Interface**Type definition**

All Spectrum driver functions are using pre-defined variable types to cover different operating systems and to use the same driver interface for all programming languages. Under Delphi it is necessary to define these types once. This is also shown in the examples delivered on CD.

Delphi type definition:

```
type
  int8   = shortint;
  pint8  = ^shortint;
  int16  = smallint;
  pint16 = ^smallint;
  int32  = longint;
  pint32 = ^longint;
  data   = array[1..MEMSIZE] of smallint;
  dataptr = ^data;
```

In the example shown above the size of data is defined to „smallint“. This definition is only valid for boards that have a sample resolution of 12, 14 or 16 bit. On 8 bit boards this has to be a „shortint“ type.

**Include Driver**

To include the driver functions into delphi it is necessary to first add them to the implementation section of the program file. There the name of the function and the location in the dll is defined:

Driver implementation:

```
function SpcSetData (nr,ch:int16; start,len:int32; data:dataptr): int16; cdecl; external 'SPECTRUM.DLL';
function SpcGetData (nr,ch:int16; start,len:int32; data:dataptr): int16; cdecl; external 'SPECTRUM.DLL';
function SpcSetParam (nr:int16; reg,value: int32): int16; cdecl; external 'SPECTRUM.DLL';
function SpcGetParam (nr:int16; reg:int32; value:pint32): int16; cdecl; external 'SPECTRUM.DLL';
function SpcInitPCIBoards (count,PCIVersion: pint16): int16; cdecl; external 'SPECTRUM.DLL';
```

Examples

Examples for Delphi can be found on CD in the directory /Examples/delphi. There is one subdirectory for each board family. You'll find board specific examples for that family there. The examples are bus type independent. As a result that means that the MI30xx directory contains examples for the MI.30xx, the MC.30xx and the MX.30xx families. The example directories contain a running project file for Borland Delphi that can be directly loaded and compiled.

Driver functions

The driver contains five functions to access the hardware.

Function SpcInitPCIBoard

This function initializes all installed PCI, PXI and CompactPCI boards. The boards are recognized automatically. All installation parameters are read out from the hardware and stored in the driver. The number of PCI boards will be given back in the value Count and the version of the PCI bus itself will be given back in the value PCIVersion.

Function SpcSetParam

All hardware settings are based on software registers that can be set by the function SpcSetParam. This function sets a register to a defined value or executes a command. The board must first be initialized. The available software registers for the driver are listed in the board specific part of the documentation below.

The value „nr“ contains the index of the board that you want to access, the value „reg“ is the register that has to be changed and the value „value“ is the new value that should be set to this software register. The function will return an error value in case of malfunction.

Function SpcGetParam

The function SpcGetParam reads out software registers or status information. The board must first be initialized. The available software registers for the driver are listed in the board specific part of the documentation below.

The value „nr“ contains the index of the board that you want to access, the value „reg“ is the register that has to be read out and the value „value“ is a pointer to a value that should contain the read parameter after function call. The function will return an error value in case of malfunction.

Function SpcSetData

Writes data to the board for a specific memory channel. The board must first be initialized. The value „nr“ contains the index of the board that you want to access, the „ch“ parameter contains the memory channel. „start“ and „len“ define the position of data to be written. „data“ is a pointer to the array holding the data. The function will return an error value in case of malfunction.



This function is only available on generator or i/o boards. The function is not available on acquisition boards.

Function SpcGetData

Reads data from the board from a specific memory channel. The board must first be initialized. The value „nr“ contains the index of the board that you want to access, the „ch“ parameter contains the memory channel. „start“ and „len“ define the position of data to be read. „data“ is a pointer to the array that should hold the data. The function will return an error value in case of malfunction.



This function is only available on acquisition or i/o boards. The function is not available on generator boards.

Visual Basic Programming Interface

The Spectrum boards can be used together with Microsoft Visual Basic as well as with Microsoft Visual Basic for Applications. This allows per example the direct access of the hardware from within Microsoft Excel. The interface between the programming language and the driver is the same for both.

Include Driver

To include the driver functions into Basic it is necessary to first add them to the module definition section of the program file. There the name of the function and the location in the dll is defined:

Module definition:

```
Public Declare Function SpcInitPCIBoards Lib "SpcStdNT.dll" Alias "_SpcInitPCIBoards@8" (ByRef Count As Integer,
ByRef PCIVersion As Integer) As Integer
Public Declare Function SpcInitBoard Lib "SpcStdNT.dll" Alias "_SpcInitBoard@8" (ByVal Nr As Integer, ByVal Typ
As Integer) As Integer
Public Declare Function SpcGetParam Lib "SpcStdNT.dll" Alias "_SpcGetParam@12" (ByVal BrdNr As Integer, ByVal
RegNr As Long, ByRef Value As Long) As Integer
Public Declare Function SpcSetParam Lib "SpcStdNT.dll" Alias "_SpcSetParam@12" (ByVal BrdNr As Integer, ByVal
RegNr As Long, ByVal Value As Long) As Integer
Public Declare Function SpcGetData8 Lib "SpcStdNT.dll" Alias "_SpcGetData@20" (ByVal BrdNr As Integer, ByVal
Channel As Integer, ByVal Start As Long, ByVal Length As Long, ByRef data As Byte) As Integer
Public Declare Function SpcSetData8 Lib "SpcStdNT.dll" Alias "_SpcSetData@20" (ByVal BrdNr As Integer, ByVal
Channel As Integer, ByVal Start As Long, ByVal Length As Long, ByRef data As Byte) As Integer
Public Declare Function SpcGetData16 Lib "SpcStdNT.dll" Alias "_SpcGetData@20" (ByVal BrdNr As Integer, ByVal
Channel As Integer, ByVal Start As Long, ByVal Length As Long, ByRef data As Integer) As Integer
Public Declare Function SpcSetData16 Lib "SpcStdNT.dll" Alias "_SpcSetData@20" (ByVal BrdNr As Integer, ByVal
Channel As Integer, ByVal Start As Long, ByVal Length As Long, ByRef data As Integer) As Integer
```

The module definition is already done for the examples and can be found in the Visual Basic examples directory. Please simply use the file declnt.bas.

Visual Basic Examples

Examples for Visual Basic can be found on CD in the directory /Examples/vb. There is one subdirectory for each board family. You'll find board specific examples for that family there. The examples are bus type independent. As a result that means that the MI30xx directory contains examples for the MI.30xx, the MC.30xx and the MX.30xx families. The example directories contain a running project file for Visual Basic that can be directly loaded.

VBA for Excel Examples

Examples for VBA for Excel can be found on CD in the directory /Examples/excel. The example here simply show the access of the driver and make a very small demo acquisition. It is necessary to combine these examples with the Visual Basic examples to have full board functionality.

Driver functions

The driver contains five functions to access the hardware.

Function SpcInitPCIBoard

This function initializes all installed PCI, PXI and CompactPCI boards. The boards are recognized automatically. All installation parameters are read out from the hardware and stored in the driver. The number of PCI boards will be given back in the value Count and the version of the PCI bus itself will be given back in the value PCIVersion.

Function SpcInitPCIBoard:

```
Function SpcInitPCIBoards (ByRef Count As Integer, ByRef PCIVersion As Integer) As Integer
```

Function SpcSetParam

All hardware settings are based on software registers that can be set by the function SpcSetParam. This function sets a register to a defined value or executes a command. The board must first be initialized. The available software registers for the driver are listed in the board specific part of the documentation below.

The value „nr“ contains the index of the board that you want to access, the value „reg“ is the register that has to be changed and the value „value“ is the new value that should be set to this software register. The function will return an error value in case of malfunction.

Function SpcSetParam:

```
Function SpcSetParam (ByVal BrdNr As Integer, ByVal RegNr As Long, ByVal Value As Long) As Integer
```

Function SpcGetParam

The function SpcGetParam reads out software registers or status information. The board must first be initialized. The available software registers for the driver are listed in the board specific part of the documentation below.

The value „nr“ contains the index of the board that you want to access, the value „reg“ is the register that has to be read out and the value „value“ is a pointer to a value that should contain the read parameter after function call. The function will return an error value in case of malfunction.

Function SpcGetParam:

```
Function SpcGetParam (ByVal BrdNr As Integer, ByVal RegNr As Long, ByRef Value As Long) As Integer
```

Function SpcSetData

Writes data to the board for a specific memory channel. The board must first be initialized. The value „nr“ contains the index of the board that you want to access, the „ch“ parameter contains the memory channel. „start“ and „len“ define the position of data to be written. „data“ is a pointer to the array holding the data. The function will return an error value in case of malfunction.

Function SpcSetData:

```
Function SpcSetData8 (ByVal BrdNr As Integer, ByVal Channel As Integer, ByVal Start As Long, ByVal Length As Long, ByRef data As Byte) As Integer
```

```
Function SpcSetData16 (ByVal BrdNr As Integer, ByVal Channel As Integer, ByVal Start As Long, ByVal Length As Long, ByRef data As Integer) As Integer
```



It is necessary to select the function with the matching data width from the above mentioned data write functions. Use the SpcSetData8 function for boards with 8 bit resolution and use the SpcSetData16 function for boards with 12, 14 and 16 bit resolution.



This function is only available on generator or i/o boards. The function is not available on acquisition boards.

Function SpcGetData

Reads data from the board from a specific memory channel. The board must first be initialized. The value „nr“ contains the index of the board that you want to access, the „ch“ parameter contains the memory channel. „start“ and „len“ define the position of data to be read. „data“ is a pointer to the array that should hold the data. The function will return an error value in case of malfunction.

Function SpcGetData:

```
Function SpcGetData8 (ByVal BrdNr As Integer, ByVal Channel As Integer, ByVal Start As Long, ByVal Length As Long, ByRef data As Byte) As Integer
```

```
Function SpcGetData16 (ByVal BrdNr As Integer, ByVal Channel As Integer, ByVal Start As Long, ByVal Length As Long, ByRef data As Integer) As Integer
```



It is necessary to select the function with the matching data width from the above mentioned data read functions. Use the SpcGetData8 function for boards with 8 bit resolution and use the SpcGetData16 function for boards with 12, 14 and 16 bit resolution.



This function is only available on acquisition or i/o boards. The function is not available on generator boards.

Programming the Board

Overview

The following chapters show you in detail how to program the different aspects of the board. For every topic there's a small example. For the examples we focussed on Visual C++. However as shown in the last chapter the differences in programming the board under different programming languages are marginal. This manual describes the programming of the whole hardware family. Some of the topics are similar for all board versions. But some differ a little bit from type to type. Please check the given tables for these topics and examine carefully which settings are valid for your special kind of board.

Register tables

The programming of the boards is totally software register based. All software registers are described in the following form:

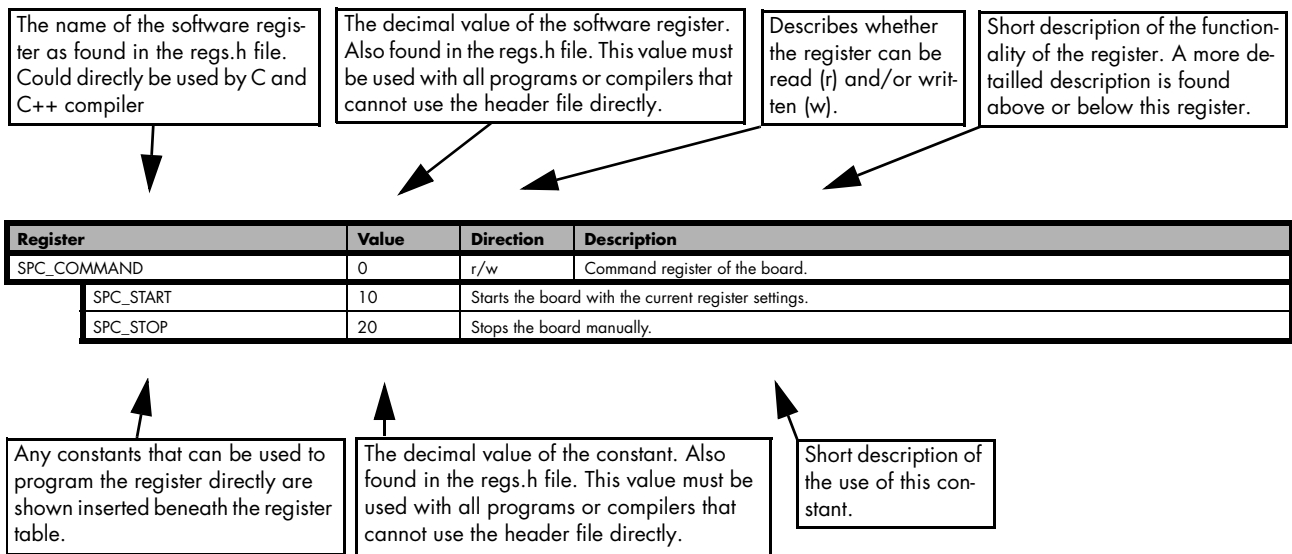

If no constants are given below the register table, the dedicated register is used as a switch. All such registers are activated if written with a "1" and deactivated if written with a "0".



Programming examples

In this manual a lot of programming examples are used to give you an impression on how the actual mentioned registers can be set within your own program. All of the examples are located in a separated colored box to indicate the example and to make it easier to differ it from the describing text.

All of the examples mentioned throughout the manual are basically written using the Visual C++ compiler for Windows. If you use Linux there are some changes in the funtion's parameter lists as mentioned in the relating software chapter.

To keep the examples as compatible as possible for users of both operational systems (Windows and Linux) all the functions that contain either a board number (Windows) or a handle (Linux) use the common parameter name 'hDrv'. Windows users simply have to set the parameter to the according board number (as the example below is showing), while Linux users can easily use the handle that is given back for the according board by the initialization function.



```
// Windows users must set hDrv to the according board number before.
// Assuming that there is only one Spectrum board installed you'll
// have to set hDrv like this:

hDrv = 0;

SpcGetParam (hDrv, SPC_LASTERRORCODE, &ErrorCode); // Any command just to show the hDrv usage
```

Error handling

If one action caused an error in the driver this error and the register and value where it occurs will be saved.

The driver is then locked until the error is read out using the SPC_LASTERRORCODE function. All other functions will lead to the same errorcode unless the error is cleared by reading SPC_LASTERRORCODE.



This means as a result that it is not necessary to check each driver call for an error but to check for an error before the board is started to see whether all settings have been valid.

By reading all the error information one can easily examine where the error occurred. The following table shows all the error related registers that can be read out.

Register	Value	Direction	Description
SPC_LASTERRORCODE	999999	r	Error code of the last error that occurred. The errorcodes are found in spcerr.h. If this register is read, the driver will be unlocked.
SPC_LASTERRORREG	999998	r	Software register that causes the error.
SPC_LASTERRORVALUE	999997	r	The value that has been written to the faulty software register.



The error codes are described in detail in the appendix. Please refer to this error description and the description of the software register to examine the cause for the error message.

Example for error checking:

```

SpcSetParam (hDrv, SPC_MEMSIZE, -345); // faulty command
if (SpcSetParam (hDrv, SPC_COMMAND, SPC_START) != ERR_OK) // try to start and check for an error
{
    SpcGetParam (hDrv, SPC_LASTERRORCODE, &lErrorCode); // read out the error information
    SpcGetParam (hDrv, SPC_LASTERRORREG, &lErrorReg);
    SpcGetParam (hDrv, SPC_LASTERRORVALUE, &lErrorValue);
    printf („Error %d when writing Register %d with Value %d !\n“, lErrorCode, lErrorReg, &lErrorValue);
}
    
```

This short program then would generate a printout as:

```

Error 101 when writing Register 10000 with Value -345 !
    
```

Initialization

Starting the automatic initialization routine

Before you can access the boards in your program, you have to initialize them first. Therefore the Spectrum function SpcInitPCIBoards is used. If it is called, all Spectrum boards in the host system are initialized automatically. If no errors occurred during the initialization, the returned value is 0 (ERR_OK). In any other cases something has gone wrong. Please see appendix for explanations of the different error codes.

If the process of initializing the boards was successful, the function returns the total number of Spectrum boards that have been found in your system. The third return value is the revision of the PCI Bus, the Spectrum boards are installed in.

The following example shows how to start the initialization of the board and check for errors.

```

// ----- Initialization of PCI Bus Boards-----
if (SpcInitPCIBoards (&nCount, &nPCIBusVersion) != ERR_OK)
    return;
if (nCount == 0)
{
    printf ("No Spectrum board found\n");
    return;
}
    
```

PCI Register

These registers are set by the driver after the initialization. The information is found in the on-board ROM, and can easily be read out by your own application software. All of the following PCI registers are read only. You get access to all registers by using the Spectrum function SpcGetParam with one of the following registers.

Register	Value	Direction	Description
SPC_PCITYP	2000	r	Type of board as listed in the table below

One of the following values are returned, when reading this register.

Boardtype	Value hexadecimal	Value decimal	Boardtype	Value hexadecimal	Value decimal
TYP_MX7210	27210h	160272	TYP_MX7220	27220h	160288

Hardware version

Since all of the MI, MC and MX boards from Spectrum are modular boards, they consist of one base board and one or two (only PCI and CompactPCI) piggy-back modules. This register SPC_PCIVERSION gives information about the revision of either the base board and the modules. Normally you do not need this information but if you have a support question, please provide the revision together with it.

Register	Value	Direction	Description
SPC_PCIVERSION	2010	r	Board revision: bit 15..8 show revision of the base card, bit 7..0 the revision of the modules

If your board has a piggy-back expansion module mounted (MC und MI series boards only) you can get the hardwareversion with the following register.

Register	Value	Direction	Description
SPC_PCIEXTVERSION	2011	r	Board's expansion module hardware revision as integer value.

Date of production

This register informs you about the production date, which is returned as one 32 bit longword. The upper word is holding the information about the year, while the lower byte informs about the month. The second byte (counting from below) is not used. If you only need to know the production year of your board you have to mask the value accordingly. Normally you do not need this information, but if you have a support question, please provide the revision within.

Register	Value	Direction	Description
SPC_PCIDATE	2020	r	Production date: year in bit 31..16, month in bit 7..0, bit 15..8 are not used

Serial number

This register holds the information about the serial number of the board. This number is unique and should always be sent together with a support question. Normally you use this information together with the register SPC_PCITYP to verify that multiple measurements are done with the exact same board.

Register	Value	Direction	Description
SPC_PCISERIALNO	2030	r	Serial number of the board

Maximum possible sample rate

This register gives you the maximum possible samplerate the board can run however. The information provided here does not consider any restrictions in the maximum speed caused by special channel settings. For detailed information about the correlation between the maximum samplerate and the number of activated channels please refer to the according chapter.

Register	Value	Direction	Description
SPC_PCISAMPLERATE	2100	r	Maximum samplerate in Hz as a 32 bit integer value

Installed memory

This register returns the size of the installed on-board memory in bytes as a 32 bit integer value. If you want to know the amount of samples you can store, you must regard the size of one sample of your Spectrum board. All 8 bit boards can store only sample per byte, while all other boards with 12, 14 and 16 bit use two bytes to store one sample.

Register	Value	Direction	Description
SPC_PCIMEMSIZE	2110	r	Installed memory in bytes as a 32 bit integer value

The following example is written for a „two bytes“ per sample board (12, 14 or 16 bit board).

```
SpcGetParam (hDrv, SPC_PCIMEMSIZE, &lInstMemsize);
printf ("Memory on board: %ld MBytes (%ld MSamples)\n", lInstMemsize / 1024 / 1024, lInstMemsize / 1024 / 1024 / 2);
```

Installed features and options

The SPC_PCIFEATURES register informs you about the options, that are installed on the board. If you want to know about one option being installed or not, you need to read out the 32 bit value and mask the interesting bit.

Register	Value	Direction	Description
SPC_PCIFEATURES	2120	r	PCI feature register. Holds the installed features and options as a bitfield, so the return value must be masked with one of the masks below to get information about one certain feature.
PCIBIT_MULTI	1		Is set if the Option Multiple Recording / Multiple Replay is installed.
PCIBIT_DIGITAL	2		Is set if the Option Digital Inputs / Digital Outputs is installed.
PCIBIT_GATE	32		Is set if the Option Gated Sampling / Gated Replay is installed.
PCIBIT_SYNC	512		Is set if the Option Synchronization is installed for that certain board, regardless what kind of synchronization you use. Boards without this option cannot be synchronized with other boards.
PCIBIT_TIMESTAMP	1024		Is set if the Option Timestamp is installed.
PCIBIT_STARHUB	2048		Is set on the board, that carries the starhub piggy-back module. This flag is set in addition to the PCIBIT_SYNC flag mentioned above. If on no synchronized board the starhub option is installed, the boards are synchronized with the cascading option.
PCIBIT_XIO	8192		Is set if the Option Extra I/O is installed.
PCIBIT_AMPLIFIER	16384		Arbitrary Waveform Generators only: card has additional set of calibration values for amplifier card

The following example demonstrates how to read out the information about one feature.

```
SpCGetParam (hDrv, SPC_PCIFEATURES, &lFeatures);

if (lFeatures & PCIBIT_DIGITAL)
    printf("Option digital inputs is installed on your board");
```

Used interrupt line

This register holds the information of the actual used interrupt line for the board. This information is sometimes more easy in getting the interrupt line of one specific board then using the hardware setups of your operating system.

Register	Value	Direction	Description
SPC_PCINTERRUPT	2300	r	The used interrupt line of the board.

Used type of driver

This register holds the information about the driver that is actually used to access the board. Although most users will use the boards within a Windows system and most Windows users will use the WDM driver, it can be sometimes necessary of knowing the type of driver.

Register	Value	Direction	Description
SPC_GETDRVTYPE	1220	r	Gives information about what type of driver is actually used
DRVTYPE_DOS	0		DOS driver is used
DRVTYPE_LINUX	1		Linux driver is used
DRVTYPE_VXD	2		Windows VXD driver is used (only Windows 95)
DRVTYPE_NTLEGACY	3		Windows NT Legacy driver is used (only Windows NT)
DRVTYPE_WDM	4		Windows WDM driver is used (only Windows 98/ME/2000/XP). This is the most common Windows driver.

Driver version

This register informs Windows users about the actual used driver DLL. This information can also be obtained from the device manager. Please refer to the „Driver Installation“ chapter. Linux users will get the revision of their kernel driver instead, because linux does not use any DLL.

Register	Value	Direction	Description
SPC_GETDRVVERSION	1200	r	Gives information about the driver DLL version

Kernel Driver version

This register informs OS independent about the actual used kernel driver. Windows users can also get this information from the device manager. Please refer to the „Driver Installation“ chapter. Linux users can get the driver version by simply accessing the following register for the kernel driver.

Register	Value	Direction	Description
SPC_GETKERNELVERSION	1210	r	Gives information about the kernel driver version.

Example program for the board initialization

The following example is only an excerpt to give you an idea on how easy it is to initialize a Spectrum board.

```
// ----- Initialization of PCI Bus Boards -----
if (SpcInitPCIBoards (&nCount, &nPCIBusVersion) != ERR_OK)
    return;

if (nCount == 0)
{
    printf ("No Spectrum board found\n");
    return;
}

// ----- request and print Board type and some information -----
SpcGetParam (hDrv, SPC_PCITYP, &lBrdType);
SpcGetParam (hDrv, SPC_PCIMEMSIZE, &lInstMemsize);
SpcGetParam (hDrv, SPC_PCISERIALNO, &lSerialNumber);

// ----- print the board type depending on bus. Board number is always the lower 16 bit of type -----
switch (lBrdType & TYP_SERIESMASK)
{
    case TYP_MISERIES:
        printf ("Board found:      MI.%x sn: %05d\n", lBrdType & 0xffff, lSerialNumber);
        break;

    case TYP_MC SERIES:
        printf ("Board found:      MC.%x sn: %05d\n", lBrdType & 0xffff, lSerialNumber);
        break;

    case TYP_MX SERIES:
        printf ("Board found:      MX.%x sn: %05d\n", lBrdType & 0xffff, lSerialNumber);
        break;
}

printf ("Memory on board: %ld MBytes (%ld MSamples)\n", lInstMemsize /1024/1024, lInstMemsize /1024/1024 /2);
printf ("Serial Number:   %05ld\n", lSerialNumber);
```

Powerdown and reset

Every Spectrum board can be set to powerdown mode by software. In this mode the board is therefore consuming less power than in normal operation mode. The amount of saved power is board dependant. Please refer to the technical data section for details. The board can be set to normal mode again either by performing a reset as mentioned below or by starting the board as described in the according chapters later in this manual.

If the board is set to powerdown mode or a reset is performed the data in the on-board memory will be no longer valid and therefore cannot be read out or replayed again.



Performing a board reset or powering down the board can be easily done by the related board commands mentioned in the following table.

Register	Value	Direction	Description
SPC_COMMAND	0	r/w	Command register of the board.
SPC_POWERDOWN	30		Sets the board to powerdown mode. The data in the on-board memory is no longer valid and cannot be read out or replayed again. The board can be set to normal mode again by the reset command or by starting the boards.
SPC_RESET	0		A software and hardware reset is done for the board. All settings are set to the default values. The data in the board's on-board memory will be no longer valid.

Digital Outputs

Channel Selection

One key setting that influences nearly all other possible settings is the channel enable register. An unique feature of the Spectrum boards is the possibility to program the data width. All on-board memory can then be used by samples with the actual data width.

This description shows you the channel enable register for the complete board family. However your specific board may have less output bits depending on the board type you purchased does not allow you to set the maximum number of bits shown here.

Register	Value	Direction	Description
SPC_CHENABLE	11000	r/w	Sets the channel enable information for the next board run.
MOD0_8BIT	1		Activates 8 bit mode for module 0. (Channel 0)
MOD0_16BIT	3		Activates 16 bit mode for module 0. (Channel 0)

The channel enable register is set as a bitfield, relating to the different modules. That means that on one module you use one of the relating values for that module, either the value for 8 bit or for 16 bit mode.

Example showing how to activate 16 bits:

```
SpcSetParam (hDrv, SPC_CHENABLE, MOD0_16BIT);
```

The following table shows all allowed settings for the channel enable register.

Activated channels and samplewidth		Values to program	Value as hex	Value as decimal
Ch0 8 bit	Ch0 16 bit			
x		MOD0_8BIT	1h	1
	x	MOD0_16BIT	3h	3

Reading out the channel enable register can be done directly after setting it or later like this:

```
SpcGetParam (hDrv, SPC_CHENABLE, &lActivatedChannels);
printf ("Activated channels are: %ld \n", lActivatedChannels);
```

Important note on channels selection

 **As some of the manuals passages are used in more than one hardware manual most of the registers and channel settings throughout this handbook are described for the maximum number of possible channels that are available on one board of the actual series. There can be less channels on your actual type of board or bus-system. Please refer to the table(s) above to get the actual number of available channels.**

Setting up the bitmask

An unique feature of the Spectrum pattern generator boards is the possibility to disable every single bit of the output. If an output bit is deactivated, it will be set to high impedance (tristate). The outputs then can be pushed within the limits of the programmed output levels.

The bits are enabled/disabled with the help of a bitmask that is implemented as a 32 bit integer value that can be set or read out with the following register.

Register	Value	Direction	Description
SPC_BITENABLE	11030	r/w	Sets the channel enable information for every single bit for the next board run. A 1 indicates, that the bit is enabled, while a 0 disables the bit.

The upper 16 bits (upper word) is the 16 bit wide bitmask for module 1 (channel 1), while the lower word is the 16 bit wide bitmask for module 0 (channel 0).

The following example shows how to activate the even bits on module 0 and the odd bits on module 1. It is assumed, that both modules each are set up correctly for 16 bit mode:

```
SpcSetParam (hDrv, SPC_BITENABLE, 0xAAAA5555); // Only enable odd bits on module 1 and even bits on module 0
```

The priority of the bitmask is lower than the one of the channel enable settings. As a result you only can deactivate unused bits, but not activate bits that are disabled because of the channel settings (all odd bits is 8 bit or 2x 8 bit single-ended mode). This mask is set to 0h internally by default, so that all outputs are disabled.



Setting up the outputs

Programming the output levels

One of the most impressive features of the 72xx pattern generator series is the high number of different logic levels that can be programmed per board.

The levels are generated by a 16 bit Digital-to-Analog converter (DAC). Every pair of logic levels therefore require one pair of DACs. As there are eight available DACs on one 16 bit module, you can program the level for a group of every four output bits. This is a maximum of up to eight different logic levels on a 32 bit board. The simplified block diagram is shown in the figure at the right.

Please keep in mind that the actually numbering of the used output bits can differ from the numbering of the data bits depending on the programmed sample width. This is done to enable you to use all the available level setting resources (DACs and output buffers) and therefore to achieve the maximum possible output current independently from the actual programmed sample width.

The programming of the levels can simply be done by writing the desired level in millivolt to the dedicated registers shown in the table below.

As the setup of the DACs can take up some time it is not possible to change the levels while the board is running. Neither while replaying data nor when it is armed and waiting for a trigger event. To change the levels the board must be stopped first.

The current limit of one group of output bits is limited by the maximum drive capability of the buffer, which is 200 mA. Try to avoid exceeding this limit to prevent the board from getting internally disabled. For details on the boards thermal protection the corresponding status registers please look up in the relating chapter.

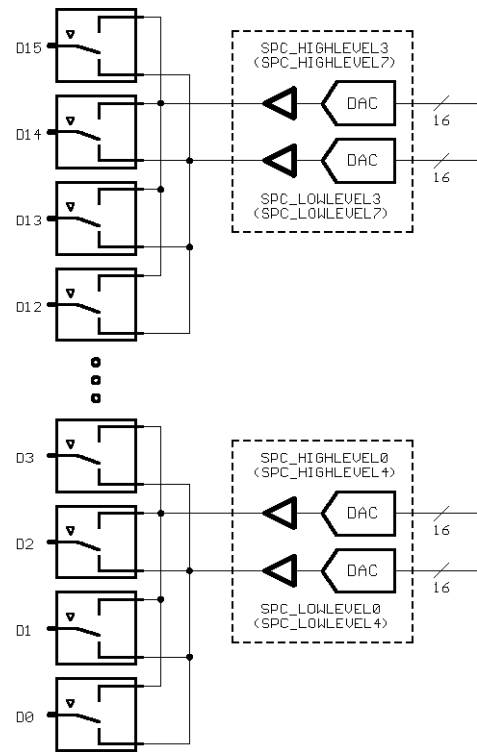

The minimum distance between a LOW level and its corresponding HIGH level for one output group is 100 mV. It is also not possible to program the LOW level of one group higher than its HIGH level. In both cases the software driver will return an error.



Register	Value	Direction	Description	Level in mV
SPC_HIGHLEVEL0	42000	r/w	Defines the HIGH level for nibble 0 (Output bit 3..0) on module 0.	-1900 to +10000
SPC_HIGHLEVEL1	42001	r/w	Defines the HIGH level for nibble 1 (Output bit 7..4) on module 0.	-1900 to +10000
SPC_HIGHLEVEL2	42002	r/w	Defines the HIGH level for nibble 2 (Output bit 11..8) on module 0.	-1900 to +10000
SPC_HIGHLEVEL3	42003	r/w	Defines the HIGH level for nibble 3 (Output bit 15..12) on module 0.	-1900 to +10000
SPC_HIGHLEVEL4	42004	r/w	Defines the HIGH level for nibble 0 (Output bit 3..0) on module 1.	-1900 to +10000
SPC_HIGHLEVEL5	42005	r/w	Defines the HIGH level for nibble 1 (Output bit 7..4) on module 1.	-1900 to +10000
SPC_HIGHLEVEL6	42006	r/w	Defines the HIGH level for nibble 2 (Output bit 11..8) on module 1.	-1900 to +10000
SPC_HIGHLEVEL7	42007	r/w	Defines the HIGH level for nibble 3 (Output bit 15..12) on module 1.	-1900 to +10000
SPC_LOWLEVEL0	42100	r/w	Defines the LOW level for nibble 0 (Output bit 3..0) on module 0.	-2000 to +9900
SPC_LOWLEVEL1	42101	r/w	Defines the LOW level for nibble 1 (Output bit 7..4) on module 0.	-2000 to +9900
SPC_LOWLEVEL2	42102	r/w	Defines the LOW level for nibble 2 (Output bit 11..8) on module 0.	-2000 to +9900
SPC_LOWLEVEL3	42103	r/w	Defines the LOW level for nibble 3 (Output bit 15..12) on module 0.	-2000 to +9900
SPC_LOWLEVEL4	42104	r/w	Defines the LOW level for nibble 0 (Output bit 3..0) on module 1.	-2000 to +9900
SPC_LOWLEVEL5	42105	r/w	Defines the LOW level for nibble 1 (Output bit 7..4) on module 1.	-2000 to +9900
SPC_LOWLEVEL6	42106	r/w	Defines the LOW level for nibble 2 (Output bit 11..8) on module 1.	-2000 to +9900
SPC_LOWLEVEL7	42107	r/w	Defines the LOW level for nibble 3 (Output bit 15..12) on module 1.	-2000 to +9900

The following example shows, how to set up the board to TTL compatible output levels. All LOW levels are set to 0.2 V, while all HIGH levels are set to +2.6 V.

```
for (i = 0; i < 7; i++) // The register values are just increased from the lowest
{ // level register, so they can be set up in a simple loop.
  SpcSetParam (hDrv, (SPC_HIGHLEVEL0 + i), 2600); // Set up all Highlevels to +2.6 V (+2600 mV)
  SpcSetParam (hDrv, (SPC_LOWLEVEL0 + i), 200); // Set up all Lowlevels to 0.0 V
}
```

Single-ended outputs

The outputs are set to single-ended by default. In this mode every output bit has one corresponding memory bit. A maximum sample width of 32 bits is possible when using a board with two modules in the single-ended mode. You can switch between the single-ended and the differential mode with the following register:

Register	Value	Direction	Description
SPC_DIFFMODE	206030	r/w	Enables the differential outputs when set to „1“. When set to „0“ outputs are used as single-ended.

As mentioned before the numbering of the output bits differ from the actual sample numbering depending on the actual channel setup. The following table is showing this bit allocation in combination with the corresponding registers for the output levels

Output bit	16 bit single-ended mode	8 bit single-ended mode	Relating register for the LOW level	Relating register for the HIGH level
D15	D15	n.u.	SPC_LOWLEVEL 3 (SPC_LOWLEVEL_7)	SPC_HIGHLEVEL 3 (SPC_HIGHLEVEL_7)
D14	D14	D7		
D13	D13	n.u.		
D12	D12	D6		
D11	D11	n.u.	SPC_LOWLEVEL 2 (SPC_LOWLEVEL_6)	SPC_HIGHLEVEL 2 (SPC_HIGHLEVEL_6)
D10	D10	D5		
D9	D9	n.u.		
D8	D8	D4		
D7	D7	n.u.	SPC_LOWLEVEL 1 (SPC_LOWLEVEL_5)	SPC_HIGHLEVEL 1 (SPC_HIGHLEVEL_5)
D6	D6	D3		
D5	D5	n.u.		
D4	D4	D2		
D3	D3	n.u.	SPC_LOWLEVEL 0 (SPC_LOWLEVEL_4)	SPC_HIGHLEVEL 0 (SPC_HIGHLEVEL_4)
D2	D2	D1		
D1	D1	n.u.		
D0	D0	D0		

As it is also possible to use both modules in 8 bit mode, you can output at maximum 16 bit samples with eight different logic levels, one pair of levels per every two data bits.



The maximum output current per output is limited to 200 mA for every group of levels. This leads to a limit of 50 mA per pin in 16 bit single-ended mode and to a limit of 100 mA per pin in 8 bit single-ended mode.

```
for (i = 0; i < 7; i++) // The register values are increased from the lowest
{ // level register, they can be set up in a loop.
  SpcSetParam (hDrv, (SPC_HIGHLEVEL0 + i), 5000); // Set up all Highlevels to +5,0 V (+5000 mV)
  SpcSetParam (hDrv, (SPC_LOWLEVEL0 + i), 0); // Set up all Lowlevels to 0,0 V
}
SpcSetParam (hDrv, SPC_CHENABLE, MOD0_8BIT | MOD1_8BIT); // Set up both modules for 8 bit mode to achieve
// a higher maximum output current per pin.
SpcSetParam (hDrv, SPC_DIFFMODE, 0); // Disable the differential output mode
```

Differential outputs

The outputs are set to single-ended by default. In the differential mode every memory bit has two corresponding output bits. A maximum sample width of 16 pairs of differential outputs is possible when using a board with two modules in the differential mode. You can switch between the single-ended and the differential mode with the following register:

Register	Value	Direction	Description
SPC_DIFFMODE	206030	r/w	Enables the differential outputs when set to „1“. When set to „0“ outputs are used as single-ended.



As the inverted output bits needed for differential signals are generated in hardware only one memory bit is used for every pair of differential outputs.

The even output bits are used for replaying the positive signals (Dx +), while the odd outputs are used for replaying the inverted signals (Dx -).

Therefore the differential mode can only be activated, when the modules are set up for the 8 bit mode (see section about channel selection for details).

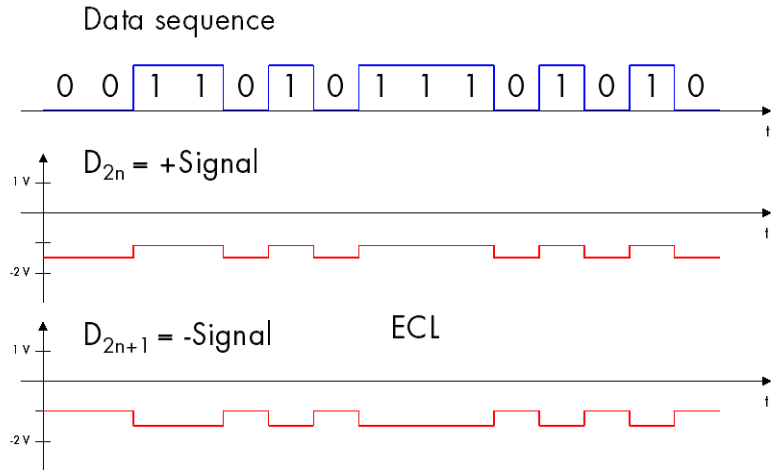

If the differential mode is used, the all of the desired outputs including the odd ones replaying the Dx- signals need to be activated by the bitmask. Please see related passage on setting up the bitmask for details.



As mentioned before the numbering of the output bits differ from the actual sample numbering depending on the actual channel setup. The following table is showing this bit allocation in combination with the corresponding registers for the output levels

Output bit	8 bit differential mode	Relating register for the LOW level	Relating register for the HIGH level
D15	- D7	SPC_LOWLEVEL 3 (SPC_LOWLEVEL_7)	SPC_HIGHLEVEL 3 (SPC_HIGHLEVEL_7)
D14	+ D7		
D13	- D6	SPC_LOWLEVEL 2 (SPC_LOWLEVEL_6)	SPC_HIGHLEVEL 2 (SPC_HIGHLEVEL_6)
D12	+ D6		
D11	- D5	SPC_LOWLEVEL 1 (SPC_LOWLEVEL_5)	SPC_HIGHLEVEL 1 (SPC_HIGHLEVEL_5)
D10	+ D5		
D9	- D4	SPC_LOWLEVEL 0 (SPC_LOWLEVEL_4)	SPC_HIGHLEVEL 0 (SPC_HIGHLEVEL_4)
D8	+ D4		
D7	- D3		
D6	+ D3		
D5	- D2		
D4	+ D2		
D3	- D1		
D2	+ D1		
D1	- D0		
D0	+ D0		

As it is also possible to use both modules in 8 bit mode, you can output at maximum 16 bit samples with eight different logic levels, one pair of levels per every two data bits.

The maximum output current per output is limited to 200 mA for every group of levels. This leads to a limit of 50 mA per pin in 8 bit differential mode.



The following program excerpt is about to give you an example on how to set up the board for differential mode to generate ECL compatible output signals as the figure above is showing.

```

for (i = 0; i < 7; i++)
{
    SpcSetParam (hDrv, (SPC_HIGHLEVEL0 + i), -1000); // The register values are just increased from the lowest
    SpcSetParam (hDrv, (SPC_LOWLEVEL0 + i), -1650); // level register, so they can be set up in a simple loop.
} // Set up all Highlevels to -1,0 V (-1000 mV)
// Set up all Lowlevels to -1,65 V (-1650 mV)
SpcSetParam (hDrv, SPC_CHENABLE, MOD0_8BIT | MOD1_8BIT); // Set up both modules for 8 bit mode
// to allow the differential mode to be selected.
SpcSetParam (hDrv, SPC_DIFFMODE, 1); // Enable the differential output mode
    
```

Programming the behavior after replay

Usually the outputs of a digital pattern generator board are set either to ground or to high impedance state after replay. This is in most cases adequate as many pattern generators generate signals with a relation to the system ground. In the case of the Spectrum 72xx series such a

behavior would not be sufficiently as you can generate signals with no relation to ground like for example ECL compatible signals. These devices do not allow to be connected to a voltage other than the family specific negative levels.

To deal with the unique output features the 72xx series you can programm the behavior of the outputs after a replay. You can choose between three different states:

- All outputs are set to the logic LOW level. When using the differential mode the odd bits (Dx-) are set to the programemd HIGH level.
- All outputs are set to the logic HIGH level. When using the differential mode the odd bits (Dx-) are set to the programemd LOW level.
- All outputs are set to high impedance state (tristate). This is valid for all bits, either in single-ended or differential mode.

The dedicated register and the possible values are shown in the following table.

Register	Value	Direction	Description
SPC_STOPLEVEL0	206020	r/w	Sets the behavior of the outputs after replay for module 0.
SPC_STOPLEVEL1	206010		Sets the behavior of the outputs after replay for module 1.
	0		All outputs of the dedicated module are set to high impedance state (tristate).
	1		All outputs of the dedicated module are set to the logic LOW level.
	2		All outputs of the dedicated module are set to the logic HIGH level



When using a 72xx series board of hardware version < V2 in all three modes all of the outputs are affected. Therefore in differential mode only the high-impedance mode should be used !

Reading the output status register

General information

To prevent the 72xx series of pattern generators from thermal damage due to overload conditions and/or too high ambient temperatures the board uses the build in thermal protection of the used line buffers. Please keep in mind that this is not a complete thermal check of all the electronic parts, but a good way to prevent the board from for example shorts at the outputs, as such errors let raise the internal temperature of the line buffers rapidly.



If any of the buffers has shut down itself due to thermal overload, the board's hardware detects the corresponding nibble of the outputs and deactivates all dedicated output bits. All output bits that are not included in the involved group will continue in replaying data.



To prevent the outputs from swinging, the deactivated outputs will not be reactivated automatically in case the buffer's temperature returned within the permitted range. To reactivate the relating outputs the status register shown in the table below must be readout.

On every module 9 buffers are used. Two for each output nibble and one to generate a necessary level for all output groups on one module. In case of a thermal overload on this 9th buffer, all outputs are deactivated immediately.

All of the return values mentioned in the table below are dezimal values, which are added if more than one group of outputs have been deactivated.

Register	Value	Direction	Description
SPC_READBACK	206000	r	Reads out the output status register
	1		Indicates that the output bits (3...0) of module 0 have been deactivated.
	2		Indicates that the output bits (7...4) of module 0 have been deactivated.
	4		Indicates that the output bits (11...8) of module 0 have been deactivated.
	8		Indicates that the output bits (15...12) of module 0 have been deactivated.
	16		Indicates that all output bits of module 0 have been deactivated.
	65536		Indicates that the output bits (3...0) of module 1 have been deactivated.
	131072		Indicates that the output bits (7...4) of module 1 have been deactivated.
	262144		Indicates that the output bits (11...8) of module 1 have been deactivated.
	524288		Indicates that the output bits (15...12) of module 1 have been deactivated.
	1048576		Indicates that all output bits of module 0 have been deactivated.

As the output status register is a bitfield it is easier in many cases to read out the returned 32 bit value from the register SPC_READBACK and mask the single bits seperately. The following table shows the single bits for the dedicated output nibbles. If the dedicated bit is set, an error has occured and the status is stored until the register is read out. In case that all outputs are working correctly, the value of the status register will be zero.

Bit 31	...	Bit 21	Bit 20	Bit 19	Bit 18	Bit17	Bit 16	Bit 15	...	Bit 5	Bit 4	Bit 3	Bit 2	Bit 1	Bit 0
0	...	0	Modul 1 all Nibbles	Modul 1 Nibble 3	Modul 1 Nibble 2	Modul 1 Nibble 1	Modul 1 Nibble 0	0	...	0	Modul 0 all Nibbles	Modul 0 Nibble 3	Modul 0 Nibble 2	Modul 0 Nibble 1	Modul 0 Nibble 0

The best way to prevent the board from overload is to use it under proper load conditions. If a higher output current is desired, it can be doubled using the 8 bit output mode as described earlier in this manual.



Important Note on reading out the status register

Due to the internal structure of the board any output data stored in the board's on-board memory will no longer be valid, after the output status register has been read out.



Example program

The following example shows an easy way on reading out the status register. Therefore no decimal values are tested, but a bitmask is used to take a look at the lower five bits only. The resulting hexadecimal value is simply printed out on the screen. If you want to know the status of each output nibble seperately, you need to mask every one of the five bits either for the upper and the lower word.

```
SpcGetParam (MI72XX, SPC_READBACK, &lFeedback);
if (lFeedback)
{
    printf("\n Status module 0 : %x", (lFeedback & 0x0000001F) ); // Mask the lower 5 bits of the lower word
    printf("\n Status module 1 : %x", ((lFeedback & 0x001F00001) >> 16)); // Mask the lower 5 bits of the upper word
}
else
    printf("\n No thermal error has occurred.\n");
```

The status register will also indicate an error, if you use a 7220 or 7221 board and the board is not conected to the power supply of your computer. If all outputs are permanently disabled, please check the power connection first.



Standard generation modes

General description

The generated data is replayed from the on-board memory. These modes allows generating waveforms at very high sample rates without the need to transfer the data into the board's on-board memory at high speed. These modes are running totally independent from the PC and don't need any processing power after being started.

Singleshot mode

The singleshot mode is the most simple output mode for the Spectrum boards. It simply replays the programmed data once after detecting the trigger event. The amount of memory to be replayed can be programmed by software. Any trigger source can be used to start the output. If output should be started immediately one can simply use the software trigger capabilities of the board.

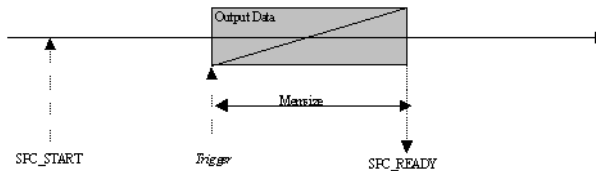

Register	Value	Direction	Description
SPC_SINGLESHOT	41000	r/w	Write a „1“ to enable the singleshot mode (a „0“ disables it)

Continuous Mode

After detecting the trigger event the programmed data is replayed continuously. On reaching end of the programmed memory size the output starts again with the first sample. There's no gap in output when switching from the last sample to the first sample. The output runs until the users stops it by software. If not stopped the continuous output runs independent of any other PC components until the system is shut down.

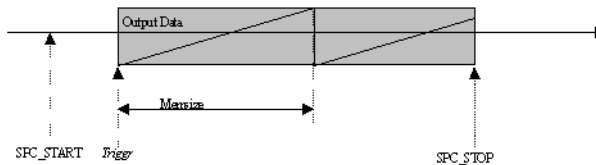

Register	Value	Direction	Description
SPC_SINGLESHOT	41000	r/w	Write a „0“ to disable the singleshot mode
SPC_OUTONTRIGGER	41100	r/w	Write a „1“ to enable the continuous mode

Posttrigger Mode

The posttrigger mode is normally only used when starting the output board together with an acquisition board. The data is written to a programmed amount of the on-board memory (memsize). After starting the board the output will immediately start and continue to loop. At this point the mode is similar to the continuous mode explained above. After detecting a trigger event, a certain programmed amount of data is replayed (posttrigger) and then the replay finishes automatically.

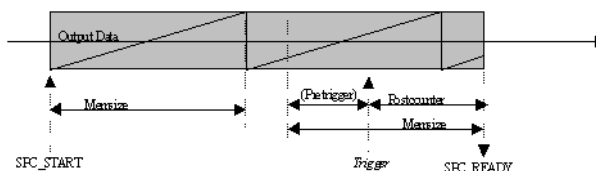

Register	Value	Direction	Description
SPC_SINGLESHOT	41000	r/w	Write a „0“ to disable the singleshot mode
SPC_OUTONTRIGGER	41100	r/w	Write a „0“ to disable the continuous mode

Programming

Partitioning the memory

The memory size register defines the length of the data to be replayed. Depending on the mode used this data is replayed once or continuously.

Register	Value	Direction	Description
SPC_MEMSIZE	10000	r/w	Sets the memory size in samples per channel.
SPC_POSTTRIGGER	10100	r/w	Sets the number of samples to be replayed after the trigger event has been detected.

The maximum memsize that can be use for replaying is of course limited by the installed amount of memory and by the number of channels to be replayed. The following table gives you an overview on the maximum memsize in relation to the installed memory.

Maximum memsize in MSamples

Activated channels and samplewidth		7210	7220
Ch0, 8 bit	Ch0, 16 bit		
x		1/1	1/1
	x	1/2	1/2

How to read this table: If you have installed the standard amount of 16 MByte on your 7020 board and you want to replay samples with a width of 16 bit, you have a total maximum memory of 16 MByte * 1/2 = 8 MSample for your data.

The maximum settings for the post counter are limited by the hardware, because the post counter has a limited range for counting. The settings depend on the number of activated channels, as the table below is showing.

Maximum posttrigger in MSamples

Activated channels and samplewidth		7210	7220
Ch0, 8 bit	Ch0, 16 bit		
x		256	256
	x	128	128

The amount of memory that can be used either for the memsize and the postcounter values can only be set by certain steps. These steps are results of the internal memory organization. For this reason these steps also define the minimum size for the data memory and the postcounter. The values depend on the number of activated channels and on the type of board being used. The minimum stepsizes for setting up the memsize and the postcounter are shown in the table below.

Minimum and stepsize of memsize and posttrigger in samples

Activated channels and samplewidth		7210	7220
Ch0, 8 bit	Ch0, 16 bit		
x		64	64
	x	32	32

Starting without interrupt (classic mode)

Command register

Register	Value	Direction	Description
SPC_COMMAND	0	read/write	Command register of the board.
SPC_START	10		Starts the board with the current register settings.
SPC_STOP	20		Stops the board manually.

In this mode the board is started by writing the SPC_START value to the command register. All settings like for example the size of memory and postcounter, the number of activated channels and the trigger settings must have been programmed before. If the start command has been given, the setup data is transferred to the board and the board will start.

If your board has relays to switch between different settings a programmed time will be waited to prevent having the influences of the relays settling time in the signal. For additional information please first see the chapter about the relay settling time. You can stop the board at any time with the command SPC_STOP. This command will stop immediately.

Once the board has been started, it is running totally independent from the host system. Your program has full CPU time to do any calculations or display. The status register shown in the table below shows the current status of the board. The most simple programming loop is simply waiting for the status SPC_READY. This status shows that the board has stopped automatically.

The read only status register can be read out at any time, but it is mostly used for polling on the board's status after the board has been started. However polling the status will need CPU time.

Status register

Register	Value	Direction	Description
SPC_STATUS	10	read	Status register, of the board.
SPC_RUN	0		Indicates that the board has been started and is waiting for a triggerevent.
SPC_TRIGGER	10		Indicates that the board is running and a triggerevent has been detected.
SPC_READY	20		Indicates that the board has stopped.

The following shortened excerpt of a sample program gives you an example of how to start the board in classic mode and how to poll for the SPC_READY flag. It is assumed that all board setup has been done before.

```
// ----- start the board -----
nErr = SpcSetParam (hDrv, SPC_COMMAND,      SPC_START);

// Here you can check for driver errors as mentioned in the relating chapter

// ----- Wait for Status Ready (polling for SPC_READY in a loop) -----
do
{
    SpcGetParam (hDrv, SPC_STATUS, &lStatus);
}
while (lStatus != SPC_READY);

printf ("Board has stopped\n");
```

Starting with interrupt driven mode

In contrast to the classic mode, the interrupt mode has no need for polling for the board's status. Starting your board in the interrupt driven mode does in the main not differ from the classic mode. But there has to be done some additional programming to prevent the program from hanging. The SPC_STARTANDWAIT command doesn't return until the board has stopped. Big advantage of this mode is that it doesn't waste any CPU time for polling. The driver is just waiting for an interrupt and the System has full CPU time for other jobs. To benefit from this mode it is necessary to set up a program with at least two different tasks: One for starting the board and to be blocked waiting for an interrupt. The other one to make any kind of calculations or display activities.

Command register

Register	Value	Direction	Description
SPC_COMMAND	0	read/write	Command register, of the board.
SPC_STARTANDWAIT	11		Starts the board with the current register settings in the interrupt driven mode.
SPC_STOP	20		Stops the board manually.



If the board is started in the interrupt mode the task calling the start function will not return until the board has finished. If no trigger event is found or the external clock is not present, this function will wait until the program is terminated from the taskmanager (Windows) or from another console (Linux).

To prevent the program from this deadlock, a second task must be used which can send the SPC_STOP signal to stop the board. Another possibility, that does not require the need of a second task is to define a timeout value.

Register	Value	Direction	Description
SPC_TIMEOUT	295130	read/write	Defines a time in ms after which the function SPC_STARTANDWAIT terminates itself. Writing a zero defines infinite wait

This is the easiest and safest way to use the interrupt driven mode. If the board started in the interrupts mode it definitely will not return until either the recording has finished or the timeout time has expired. In that case the function will return with an error code. See the appendix for details.

The following excerpt of a sample program gives you an example of how to start the board in the interrupt driven mode. It is assumed that all board setup has been done before.

```

SpcSetParam (hDrv, SPC_TIMEOUT, 1000); // Define the timeout to 1000 ms = 1 second
nErr = SpcSetParam (hDrv, SPC_COMMAND, SPC_STARTANDWAIT); // Starts the board in the interrupt driven mode

if (nErr == ERR_TIMEOUT) // Checks for the timeout
    printf ("No trigger found. Timeout has expired.\n");
    
```

An example on how to get a second task that can do some monitoring on the running task and eventually send the SPC_STOP command can be found on the Spectrum driver CD that has been shipped with your board. The latest examples can also be down loaded via our website at <http://www.spectrum-instrumentation.com>.

Data organization

In standard mode the data is organized on the board in two memory channels, named memory channel 0 and memory channel 1. Be aware that these memory channels are something different than the board channels. The data in memory is organized depending on the used channels and the type of board. This is a result of the internal hardware structure of the board.

Activated channels and sample-width				Sample ordering in standard mode on memory channel 0										Sample ordering in standard mode on memory channel 1									
Ch0, 8 bit	Ch0, 16 bit	Ch1, 8 bit	Ch1, 16 bit	A0	A1	A2	A3	A4	A5	A6	A7	A8	A9	B0	B1	B2	B3	B4	B5	B6	B7	B8	B9
x				A0	A1	A2	A3	A4	A5	A6	A7	A8	A9										
	x			A0	A1	A2	A3	A4	A5	A6	A7	A8	A9	B0	B1	B2	B3	B4	B5	B6	B7	B8	B9
		x		A0	A1	A2	A3	A4	A5	A6	A7	A8	A9	B0	B1	B2	B3	B4	B5	B6	B7	B8	B9
			x	A0	A1	A2	A3	A4	A5	A6	A7	A8	A9	B0	B1	B2	B3	B4	B5	B6	B7	B8	B9

The samples are re-named for better readability. A0 is a 16 bit sample 0 of memory channel 0, B4 is a 16 bit sample 4 of memory channel 1, ...

Writing data with SpcSetData

The function SpcSetData enables you to write data to the on-board memory before starting the generation. Depending on your operation system, the function is called with a different amount of parameters. Please refer to the relating chapter earlier in this manual. The examples in this section are written in Visual C++ for Windows, so the examples differ a little bit for the use with linux.

As the data is written individually for every memory channel, it is important to know where the data has to be stored. Please refer to the data organization section, to get the information you need first.

The function SpcSetData has two parameters that allow you to write in any position of the replay memory. That can be very helpful if only parts of the signal should be exchanged. However the user must make sure that the complete replay memory is filled with appropriate data.

The value 'start' as a 32 bit integer value

This value defines the start of the memory area to be written in samples. This result is, that you do not need to care for the number of bytes a single sample contains. If you want to write the whole memory at once this value must be set to 0.

The value 'len' as a 32 bit integer value

This value defines the number of samples that are written, beginning with the first sample defined by the 'start' value mentioned above. If you want to write to the whole on-board memory you need to set a memsize value for the board before starting the generation. This memsize must be a total memsize for all channels that are generated from that memory channel. As a result that means if generating two channels from memory channel 0 the „len“ value must be set to „2 * memsize“.

Multiplexed data

Depending on the activated channels and the board type several channels could be stored in one memory channel. As a result that means that „start“ and „len“ parameter have to be multiplied by the number of channels per memory channel (module). If for example two channels have are replayed from one memory channel a call like:

```

SpcSetData (hDrv, 0, 2 * 4096, 2 * 2048, Data);
    
```

writes data of both channels to memory channel 0 starting at sample position 4k and a length of 2k. The Data array must of course hold data of both channels (in that case $2 * 2k = 4k$ of data) multiplexed as shown above.

Standard mode

Writing data to the memory is really easy, if a replay mode is used, that stores non multiplexed data in the dedicated memory channels. The next example shows, how to write the data before replaying two channels without multiplexing to both memory channels.

```

for (i = 0; i < 2; i++) // both memory channels have been used
    pData[i] = (ptr16) malloc (lMemsize * lBytesPerSample); // allocate memory for the data pointers
// generate or load data into pData[0..1] // with the maximum size (lMemsize)

SpcSetData (hDrv, 0, 0, lMemsize, (dataptr) pData[0]); // no multiplexing is necessary on channel 0
SpcSetData (hDrv, 1, 0, lMemsize, (dataptr) pData[1]); // neither it is on channel 1
    
```

If you use two channels for replay using only one memory channel, the data in the memory channel(s) has to be multiplexed and needs to be sorted by the user. The following example shows how to sort the data for the replay of two channels using memory channel 0.

```

for (i = 0; i < 2; i++) // two channels to write to memory channel 0
    pData[i] = (ptr16) malloc (lMemsize * lBytesPerSample); // allocate memory for the data pointers
// generate or load data into pData[0..1] // with the maximum size (lMemsize) per channel

pnTmp = (ptr16) malloc (lMemsize * 2 * lBytesPerSample); // allocate temporary buffer for copy

for (i = 0; i < lMemsize; i++) // combine data of the two channels
{
    pnTmp[2*i] = pData[0][i];
    pnTmp[2*i+1] = pData[1][i];
}

SpcSetData (hDrv, 0, 0, 2 * lMemsize, (dataptr) pnTmp); // write both channels to memory channel 0

free (pnTmp); // free the temporary buffer
    
```

Sample format

Either 8 bit as well as 16 bit samples are stored in memory as 16 bit integer values. Therefore 8 bit data is stored multiplexed in memory. Due to the internal structure of the board the sample format depends on the used output mode (standard/non FIFO or FIFO mode) and on the sample width. The following table shows the sample format for the standard mode. The format for the use in FIFO mode can be found in the dedicated chapter of this manual.

Bit	Memory channel 0		Memory channel 1	
	MOD0_8BIT	MOD0_16BIT	MOD1_8BIT	MOD1_16BIT
D15	N+1 Sample Bit 7 (MSB)	N Sample Bit 15 (MSB)	N+1 Sample Bit 7 (MSB)	N Sample Bit 15 (MSB)
D14	N+1 Sample Bit 6	N Sample Bit 14	N+1 Sample Bit 6	N Sample Bit 14
D13	N+1 Sample Bit 5	N Sample Bit 13	N+1 Sample Bit 5	N Sample Bit 13
D12	N+1 Sample Bit 4	N Sample Bit 12	N+1 Sample Bit 4	N Sample Bit 12
D11	N+1 Sample Bit 3	N Sample Bit 11	N+1 Sample Bit 3	N Sample Bit 11
D10	N+1 Sample Bit 2	N Sample Bit 10	N+1 Sample Bit 2	N Sample Bit 10
D9	N+1 Sample Bit 1	N Sample Bit 9	N+1 Sample Bit 1	N Sample Bit 9
D8	N+1 Sample Bit 0 (LSB)	N Sample Bit 8	N+1 Sample Bit 0 (LSB)	N Sample Bit 8
D7	N Sample Bit 7 (MSB)	N Sample Bit 7	N Sample Bit 7 (MSB)	N Sample Bit 7
D6	N Sample Bit 6	N Sample Bit 6	N Sample Bit 6	N Sample Bit 6
D5	N Sample Bit 5	N Sample Bit 5	N Sample Bit 5	N Sample Bit 5
D4	N Sample Bit 4	N Sample Bit 4	N Sample Bit 4	N Sample Bit 4
D3	N Sample Bit 3	N Sample Bit 3	N Sample Bit 3	N Sample Bit 3
D2	N Sample Bit 2	N Sample Bit 2	N Sample Bit 2	N Sample Bit 2
D1	N Sample Bit 1	N Sample Bit 1	N Sample Bit 1	N Sample Bit 1
D0	N Sample Bit 0 (LSB)	N Sample Bit 0 (LSB)	N Sample Bit 0 (LSB)	N Sample Bit 0 (LSB)

FIFO Mode

Overview

General Information

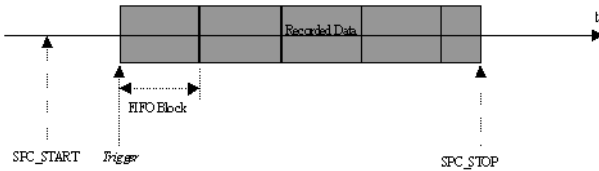

The FIFO mode allows to record data continuously and transfer it online to the PC (acquisition boards) or allows to write data continuously from the PC to the board (generation boards). Therefore the on-board memory of the board is used as a continuous buffer. On the PC the data can be used for any calculation or can be written to hard disk while recording is running (acquisition boards) or the data can be read from hard disk and calculated online before writing it to the board.

FIFO mode uses interrupts and is supported by the drivers on 32 bit and 64 bit operating systems. Start of FIFO mode waits for a trigger event. If you wish to start FIFO mode immediately, you may use the software trigger. FIFO mode can be used together with the options Multiple Recording/Replay and Gated Sampling/Replay. Details on this can be found in the appropriate chapters about the options.

Background FIFO Write

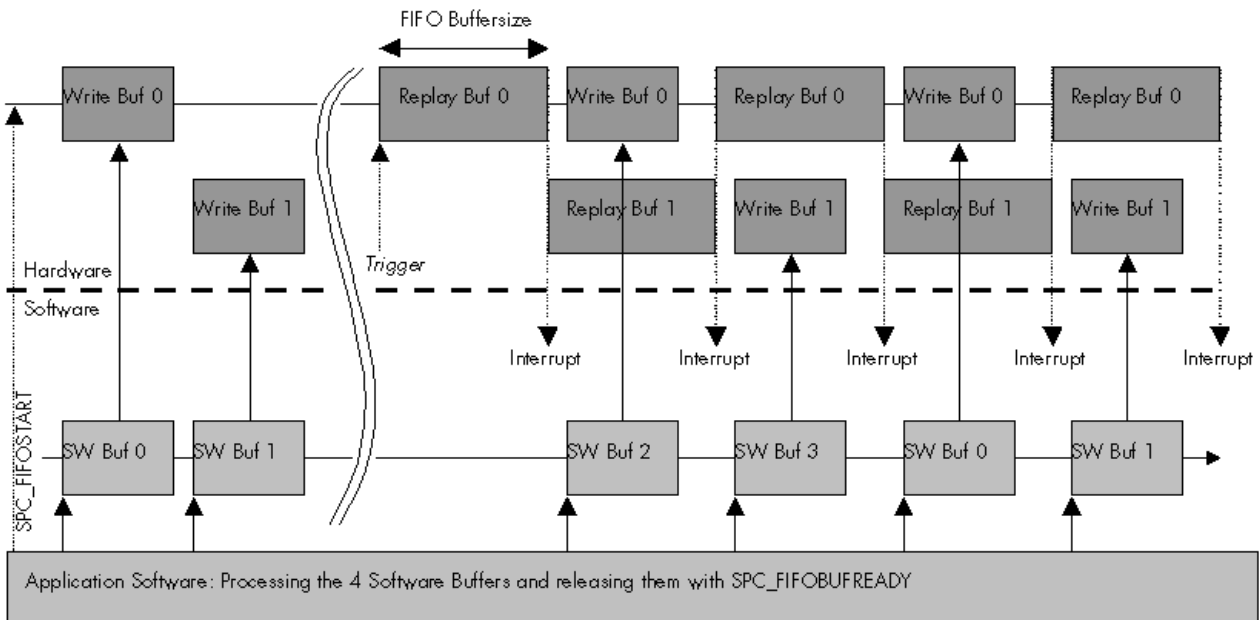

On the hardware side the memory is split in two buffers of the same length. These buffers can be up to half of the on-board memory in size. The driver holds up to 256 software buffers of the same length as the hardware buffers. Whenever a hardware buffer is empty and all data replayed the hardware generates an interrupt and the driver transfers the next software buffer to the empty hardware buffer. The driver is doing this job automatically in the background. After driver has finished transferring the data the application software gets a signal and can generate data or load the next buffer from hard disk. After processing the data the application software tells the driver that the data in the software buffer is valid and can again be used for data generation. This two stages buffering has big advantages when running FIFO mode at the speed limit. The software buffers expand the generation time that can be buffered and protects the whole system against buffer underruns.

Speed Limitations

The FIFO mode is running continuously all the time. Therefore the data must be read out from the board (data acquisition) or written to the board (data generation) at least with the same speed that it is recorded/replayed. If data is read out from the board or written to the board more slowly, the hardware buffers will overrun at a certain point and FIFO mode is stopped. One bottleneck with the FIFO mode is the PCI bus. The standard PCI bus is theoretically capable of transferring data with 33 MHz and 32 Bit. As a result a maximum burst transfer rate of 132 MByte per second can be achieved. As several devices can share the PCI bus this maximum transfer rate is only available to a short transfer burst until a new bus arbitration is necessary. In real life the continuous transfer rate is limited to approximately 100-110 MBytes per second. The maximum FIFO speed one can achieve heavily depends on the PC system and the operating system and varies from system to system. The maximum sample rate one can run in continuous FIFO mode depends on the number of activated channels:

	Theoretical maximum sample rate	PCI Bus Throughput
1 Channel	50 MS/s	[1 Channel] x [2 Bytes per sample] * 50 MS/s = 100 MB/s
2 Channels	25 MS/s	[2 Channels] x [2 Bytes per sample] * 25 MS/s = 100 MB/s
4 Channels	12.5 MS/s	[4 Channels] x [2 Bytes per sample] * 12.5 MS/s = 100 MB/s
8 Channels	6.25 MS/s	[8 Channels] x [2 Bytes per sample] * 6.25 MS/s = 100 MB/s

When using FIFO mode together with one of the options that allow to have gaps in the generation like Multiple Replay or Gated Replay one can even run the board with higher sample rates. It just has to be sure that the average sample rate (calculated with generation time and gap) does not exceed the above mentioned sample rate limitations.

The sample rate that can be run in one of these mode is depending on the number of channels that have been activated. Due to the internal structure of the board this is limited to a internal throughput of 250 MB/s (250 MS/s):

	Maximum sample rate that can be programmed	Internal throughput
1 Channel	125 MS/s	[1 Channel] x [2 Bytes per sample] x 125 MS/s = 250 MB/s
2 Channels	62.5 MS/s	[2 Channels] x [2 Bytes per sample] x 62.5 MS/s = 250 MB/s
4 Channels	31.25 MS/s	[4 Channels] x [2 Bytes per sample] x 31.25 MS/s = 250 MB/s
8 Channels	15.625 MS/s	[8 Channels] x [2 Bytes per sample] x 15.625 MS/s = 250 MB/s

Programming

The setup of FIFO mode is done with a few additional software registers described in this chapter. All the other settings can be used as described before. In FIFO mode the register SPC_MEMSIZE and SPC_POSTTRIGGER are not used.

Software Buffers

This register defines the number of software buffers that should be used for FIFO mode. The number of hardware buffers is always two and can not be changed by software.

Register	Value	Direction	Description
SPC_FIFO_BUFFERS	60000	r/w	Number of software buffers to be used for FIFO mode. Value has to be between 2 and 256

When this manual was printed there are a total of 256 buffers possible. However if there are changes and enhancements to the driver in the future it will be informative to read out the number of buffers the new driver version can hold.

Register	Value	Direction	Description
SPC_FIFO_BUFADRCNT	60040	r	Read out the number of available FIFO buffers

The length of each buffer is defined in bytes. This length is used for hardware and software buffers as well. Both have the same length. The maximum length that can be used is depending on the installed on-board memory.

Register	Value	Direction	Description
SPC_FIFO_BUFLen	60010	r/w	Length of each buffer in bytes. Must be a multiple of 1024 bytes.

Each FIFO buffer can be a maximum of half the memory. Be aware that the buffer length is given in overall bytes not in samples. Therefore the value has to be calculated depending on the activated channels and the resolution of the board:

Analog acquisition or generation boards

	Buffer length to be programmed in Bytes			
	8 bit resolution	12 bit resolution	14 bit resolution	16 bit resolution
1 Channel	1 x [Samples in Buffer]	1 x 2 x [Samples in Buffer]	1 x 2 x [Samples in Buffer]	1 x 2 x [Samples in Buffer]
2 Channels	2 x [Samples in Buffer]	2 x 2 x [Samples in Buffer]	2 x 2 x [Samples in Buffer]	2 x 2 x [Samples in Buffer]
4 Channels	4 x [Samples in Buffer]	4 x 2 x [Samples in Buffer]	4 x 2 x [Samples in Buffer]	4 x 2 x [Samples in Buffer]
8 Channels	8 x [Samples in Buffer]	8 x 2 x [Samples in Buffer]	8 x 2 x [Samples in Buffer]	8 x 2 x [Samples in Buffer]

Digital I/O (701x or 702x) or pattern generator boards (72xx)

	Buffer length to be programmed in Bytes			
	8 bit mode	16 bit mode	32 bit mode	64 bit mode
	[Samples in Buffer]	2 x [Samples in Buffer]	4 x [Samples in Buffer]	8 x [Samples in Buffer]

Digital I/O board 7005 only

	Buffer length to be programmed in Bytes				
	1 bit mode	2 bit mode	4 bit mode	8 bit mode	16 bit mode
1 Channel	1/8 x [Samples in Buffer]	1/4 x [Samples in Buffer]	1/2 x [Samples in Buffer]	[Samples in Buffer]	2 x [Samples in Buffer]

We at Spectrum achieved best results when programming the buffer length to a number of samples that can hold approximately 100 ms of data. However if going to the limit of the PCI bus with the FIFO mode or when having buffer overruns it can be useful to have larger FIFO buffers to buffer more data in it.

When the goal is a fast update in FIFO mode smaller buffers and a larger number of buffers can be a better setup.

Register	Value	Direction	Description
SPC_FIFO_BUFADRO	60100	r/w	address of FIFO buffer 0. Must be allocated by application program
SPC_FIFO_BUFADR1	60101	r/w	address of FIFO buffer 1. Must be allocated by application program
...			...
SPC_FIFO_BUFADR255	60355	r/w	address of FIFO buffer 255. Must be allocated by application program

The driver handles the programmed number of buffers. To speed up FIFO transfer the driver uses buffers that are allocated and maintained by the application program. Before starting the FIFO mode the addresses of the allocated buffers must be set to the driver.

Example of FIFO buffer setup. Neither memory allocation nor error checking is done in the example to improve readability:

```

// ----- setup FIFO buffers -----
SpcSetParam (hDrv, SPC_FIFO_BUFFERS, 64); // 64 FIFO buffers used in the example
SpcSetParam (hDrv, SPC_FIFO_BUFLen, 8192); // Each FIFO buffer is 8 kBytes long

// ----- allocate memory for data -----
for (i = 0; i < 64; i++)
    pData[i] = (ptr16) malloc (8192); // memory allocation for 12, 14, 16 bit analog boards
// and digital boards
// pbyData[i] = (ptr8) malloc (8192); // memory allocation for 8 bit analog boards

// ----- tell the used buffer addresses to the driver -----
for (i = 0; i < 64; i++)
    nErr = SpcSetParam (hDrv, SPC_FIFO_BUFADRO + i, (int32) pData[i]); // for 12, 14, 16 bit analog boards
// and digital boards only
// nErr = SpcSetParam (hDrv, SPC_FIFO_BUFADRO + i, (int32) pbyData[i]); // for 8 bit analog boards only
    
```

When using 64 bit Linux systems it is necessary to program the buffer addresses using a special function as the SpcSetParam function is limited to 32 bit as a parameter. Under 64 bit Linux systems all addresses are 64 bit wide. Please use the function SpcSetAdr as described in the introduction and shown in the example below:



```

// ----- tell the used buffer addresses to the driver (Linux 32 and 64 bit systems) -----
for (i = 0; i < 64; i++)
    nErr = SpcSetAdr (hDrv, SPC_FIFO_BUFADRO + i, (void*) pData[i]);
    
```

Buffer processing

The driver counts all the software buffers that have been transferred. This number can be read out from the driver to know the exact amount of data that has been transferred.

Register	Value	Direction	Description
SPC_FIFO_BUFCount	60020	r	Number of transferred buffers until now

If one knows before starting FIFO mode how long this should run it is possible to program the number of buffers that the driver should process. After transferring this number of buffer the driver will automatically stop. If FIFO mode should run endless a zero must be programmed to this register. Then the FIFO mode must be stopped by the user.

Register	Value	Direction	Description
SPC_FIFO_BUFMAXCNT	60030	r/w	Number of buffers to be transferred until automatic stop. Zero runs endless

FIFO mode

In normal applications the FIFO mode will run in a loop and process one buffer after the other. There are a few special commands and registers for the FIFO mode:

Register	Value	Direction	Description
SPC_COMMAND	0	w	Command register. Allowed values for FIFO mode are listed below
SPC_FIFOSTART	12		Starts the FIFO mode and waits for the first interrupt
SPC_FIFOWAIT	13		Waits for the next buffer interrupt
SPC_STOP	20		Stops the FIFO mode

The start command and the wait command both wait for the signal from the driver that the next buffer has to be processed. This signal is generated by the driver on receiving an interrupt from the hardware. While waiting none of these commands waste cpu power (no polling mode). If for any reason the signal is not coming from the hardware (e.g. trigger is not found) the FIFO mode must be stopped from a second task with a stop command.

This handshake command tells the driver that the application has finished it's work with the software buffer. The both commands SPC_FIFOWAIT (SPC_FIFOSTART) and SPC_FIFO_BUFFERS form a simple but powerful handshake protocol between application software and board driver.

Register	Value	Direction	Description
SPC_FIFO_BUFREADY	60050	w	FIFO mode handshake. Application has finished with that buffer. Value is index of buffer



Backward compatibility: This register replaces the formerly known SPC_FIFO_BUFREADYO... SPC_FIFO_BUFREADY15 commands. It has the same functionality but can handle more FIFO buffers. For backward compatibility the older commands still work but are still limited to 16 buffers.

Example FIFO generation mode

This example shows the main loop of a FIFO generation. The example is a part of the FIFO examples that are available for each board on CD. The example simply calls a routine for output data calculation and counts the buffers that has been processed.

FIFO generation example:

```
// ----- fill the first buffers with data -----
for (i=0; i<MAX_BUF; i++)
    vCalcOutputData (pnData[i], BUFSIZE);

// ----- start the board -----
nBufIdx = 0;
lCommand = SPC_FIFOSTART;
lBufCount = 0;

printf ("Start\n");
do
{
    nErr = SpcSetParam (hDrv, SPC_COMMAND,      lCommand);
    lCommand = SPC_FIFOWAIT;

    // ----- driver requests next buffer: calculate it or load if from disk -----
    printf ("Buffer %d\n", lBufCount);
    vCalcOutputData (pnData[nBufIdx], BUFSIZE);

    // ----- buffer is ready -----
    SpcSetParam (hDrv, SPC_FIFO_BUFREADY,      nBufIdx);

    // ----- next Buffer -----
    lBufCount++;
    nBufIdx++;
    if (nBufIdx == MAX_BUF)
        nBufIdx = 0;
}
while (nErr == ERR_OK);
```



Before starting the FIFO output all software buffers must be filled once with data. The driver immediately transfers data to the hardware after receiving the start command.

Data organization

When using FIFO mode data in memory is organized in some cases a little bit different then in standard mode. This is a result of the internal hardware structure of the board. The organization of data is depending on the activated channels:

Activated channels and sample-width				Sample ordering in FIFO buffer																				
Ch0, 8 bit	Ch0, 16 bit	Ch1, 8 bit	Ch1, 16 bit																					
x				A0	A1	A2	A3	A4	A5	A6	A7	A8	A9	A10	A11	A12	A13	A14	A15	A16	A17	...		
x	x			A0	A1	A2	A3	A4	A5	A6	A7	A8	A9	A10	A11	A12	A13	A14	A15	A16	A17	...		
x		x		Y0	Y1	Y2	Y3	Y4	Y5	Y6	Y7	Y8	Y9	Y10	Y11	Y12	Y13	Y14	Y15	Y16	Y17	...		
x	x		x	A0	B0	A1	B1	A2	B2	A3	B3	A4	B4	A5	B5	A6	B6	A7	B7	A8	B8	...		

The samples are re-named for better readability. A0 is a 16 bit sample 0 of channel 0, B4 is a 16 bit sample 4 of channel 1, ... The 16 bit samples re-named as Y contain the data for both 8bit channels as described in the passage related to the sample format in FIFO mode.

The following example shows how to write the 16 bit samples when using both modules in FIFO mode:

```

for (i = 0; i < lBufferSizeInSamples; i+=2)
{
    FIFOBuffer[i + 0] = Data[0][i/2];
    FIFOBuffer[i + 1] = Data[1][i/2];
}
    
```

Sample format

Either 8 bit as well as 16 bit samples are stored in memory as 16 bit integer values. Therefore 8 bit data is stored multiplexed in memory. Due to the internal structure of the board the sample format depends on the used output mode (standard/non FIFO or FIFO mode) and on the sample width. The following table shows the sample format for the standard mode. The format for the use in FIFO mode can be found in the dedicated chapter of this manual.

Bit	MOD0_8BIT	MOD0_16BIT	MOD0_8BIT MOD1_8BIT	MOD0_16BIT MOD1_16BIT
D15	N+1 sample, bit 7 (MSB)	N sample, bit 15 (MSB)	Module 1 N sample, bit 7 (MSB)	N sample, bit 15 (MSB)
D14	N+1 sample, bit 6	N sample, bit 14	Module 1 N sample, bit 6	N sample, bit 14
D13	N+1 sample, bit 5	N sample, bit 13	Module 1 N sample, bit 5	N sample, bit 13
D12	N+1 sample, bit 4	N sample, bit 12	Module 1 N sample, bit 4	N sample, bit 12
D11	N+1 sample, bit 3	N sample, bit 11	Module 1 N sample, bit 3	N sample, bit 11
D10	N+1 sample, bit 2	N sample, bit 10	Module 1 N sample, bit 2	N sample, bit 10
D9	N+1 sample, bit 1	N sample, bit 9	Module 1 N sample, bit 1	N sample, bit 9
D8	N+1 sample, bit 0 (LSB)	N sample, bit 8	Module 1 N sample, bit 0 (LSB)	N sample, bit 8
D7	N sample, bit 7 (MSB)	N sample, bit 7	Module 0 N sample, bit 7 (MSB)	N sample, bit 7
D6	N sample, bit 6	N sample, bit 6	Module 0 N sample, bit 6	N sample, bit 6
D5	N sample, bit 5	N sample, bit 5	Module 0 N sample, bit 5	N sample, bit 5
D4	N sample, bit 4	N sample, bit 4	Module 0 N sample, bit 4	N sample, bit 4
D3	N sample, bit 3	N sample, bit 3	Module 0 N sample, bit 3	N sample, bit 3
D2	N sample, bit 2	N sample, bit 2	Module 0 N sample, bit 2	N sample, bit 2
D1	N sample, bit 1	N sample, bit 1	Module 0 N sample, bit 1	N sample, bit 1
D0	N sample, bit 0 (LSB)	N sample, bit 0 (LSB)	Module 0 N sample, bit 0 (LSB)	N sample, bit 0 (LSB)

Clock generation

Overview

The Spectrum boards offer a wide variety of different clock modes to match all the customers needs. All the clock modes are described in detail with programming examples below. This chapter simply gives you an overview which clock mode to select:

Standard internal sample rate

PLL with internal 40 MHz reference. This is the easiest way to generate a sample rate with no need for additional external clock signals. The sample rate has a fine resolution.

Quartz and divider

Internal quartz clock with divider. For applications that need a lower clock jitter than the PLL produces. The possible sample rates are restricted to the values of the divider.

External reference clock

PLL with external 1 MHz to 125 MHz reference clock. This provides a very good clock accuracy if a stable external reference clock is used. It also allows the easy synchronization with an external source.

External clock

Any clock can be fed in that matches the specification of the board. The external clock signal can be used to synchronize the board on a system clock or to feed in an exact matching sample rate.

External clock with divider

The externally fed in clock can be divided to generate a low-jitter sample rate of a slower speed than the external clock available.



There is a more detailed description of the clock generation part available as an application note. There some more background information and details of the internal structure are explained.

PXI reference clock

The PXI 10 MHz reference clock is used in conjunction with the on-board PLL to generate the sampling clock. All PXI cards then have a fixed phase relation between each other.

Internally generated sample rate

Standard internal sample rate

The internal sample rate is generated in default mode by a PLL and dividers out of an internal 40 MHz frequency reference. In most cases the user does not need to care on how the desired sample rate is generated by multiplying and dividing internally. You simply write the desired sample rate to the according register shown in the table below. If you want to make sure the sample rate has been set correctly you can also read out the register and the driver will give you back the sample rate that is matching your desired one best.

Register	Value	Direction	Description
SPC_SAMPLERATE	20000	w	Defines the sample rate in Hz for internal sample rate generation.
		r	Read out the internal sample rate that is nearest matching to the desired one.

If a sample rate is generated internally, you can additionally enable the clock output. The clock will be available on the external clock connector and can be used to synchronize external equipment with the board.

Register	Value	Direction	Description
SPC_EXTERNOUT	20110	r/w	Enables clock output on external clock connector. Only possible with internal clocking. (old name)
SPC_CLOCKOUT	20110	r/w	Enables clock output on external clock connector. Only possible with internal clocking. (new name)

Example on writing and reading internal sample rate

```

SpcSetParam (hDrv, SPC_SAMPLERATE, 1000000); // Set internal sample rate to 1 MHz
SpcSetParam (hDrv, SPC_CLOCKOUT, 1); // enable the clock output of that 1 MHz
SpcGetParam (hDrv, SPC_SAMPLERATE, &lSamplerate); // Read back the sample rate that has been programmed
printf („Samplerate = %d\n“, lSamplerate); // print it. Output should be „Samplerate = 1000000“

```

Minimum internal sample rate

The minimum internal sample rate is limited on all boards to 1 kHz and the maximum sample rate depends on the specific type of board. The maximum sample rates for your type of board are shown in the tables below.

Maximum internal sample rate in MS/s normal mode

Activated channels and samplewidth		7210	7220
Ch0, 8 bit	Ch0, 16 bit		
x		10	40
	x	10	40

Using plain quartz without PLL

In some cases it is useful for the application not to have the on-board PLL activated. Although the PLL used on the Spectrum boards is a low-jitter version it still produces more clock jitter than a plain quartz oscillator. For these cases the Spectrum boards have the opportunity to switch off the PLL by software and use a simple clock divider.

Register	Value	Direction	Description
SPC_PLL_ENABLE	20030	r/w	A „1“ enables the PLL mode (default) or disables it by writing a 0 to this register

The sample rates that could be set are then limited to the quartz speed divided by one of the below mentioned dividers. The quartz used on the board is similar to the maximum sample rate the board can achieve. As with PLL mode it's also possible to set a desired sample rate and read it back. The result will then again be the best matching sample rate.

Available divider values

1 2 4 8 10 16 20 40 50 80 100 200
 400 500 800 1000 2000

External reference clock

If you have an external clock generator with a extremely stable frequency, you can use it as a reference clock. You can connect it to the external clock connector and the PLL will be fed with this clock instead of the internal reference. Due to the fact that the driver needs to know the external fed in frequency for an exact calculation of the sample rate you must set the the SPC_REFERENCECLOCK register accordingly as shown in the table below:

Register	Value	Direction	Description
SPC_REFERENCECLOCK	20140	r/w	Programs the external reference clock in the range from 1 MHz to 125 MHz.
	0		Internal reference is used for internal sampling rate generation
	External sample rate in Hz as an integer value		External reference is used. You need to set up this register exactly to the frequency of the external fed in clock.

The driver automatically sets the PLL to achieve the desired sample rate. Therefore it examines the reference clock and the sample rate registers.

Example of reference clock:

```
SpSetParam (hDrv, SPC_EXTERNALCLOCK, 0);           // Set to internal clock
SpSetParam (hDrv, SPC_REFERENCECLOCK, 10000000); // Reference clock that is fed in is 10 MHz
SpSetParam (hDrv, SPC_SAMPLERATE, 25000000);     // We want to have 25 MHz as sample rate
```

Termination of the clock input

If the external connector is used as an input, either for feeding in an external reference clock or for external clocking you can enable a 50 Ohm termination on the board. If the termination is disabled, the impedance is high. Please make sure that your source is capable of driving that current and that it still fulfills the clock input specification as given in the technical data section.

Register	Value	Direction	Description
SPC_CLOCK50OHM	20120	read/write	A „1“ enables the 50 Ohm termination at the external clock connector. Only possible, when using the external connector as an input.

External clocking

Direct external clock

An external clock can be fed in on the external clock connector of the board. This can be any clock, that matches the specification of the board. The external clock signal can be used to synchronize the board on a system clock or to feed in an exact matching sample rate.

Register	Value	Direction	Description
SPC_EXTERNALCLOCK	20100	r/w	Enables the external clock input. If external clock input is disabled, internal clock will be used.

The maximum values for the external clock is board dependant and shown in the table below.

Termination of the clock input

If the external connector is used as an input, either for feeding in an external reference clock or for external clocking you can enable a 110 Ohm termination on the board. If the termination is disabled, the impedance is several Kiloohm. Please make sure that your source is capable of driving that current and that it still fulfills the clock input specification as given in the technical data section.

Register	Value	Direction	Description
SPC_CLOCK110OHM	20120	r/w	A „1“ enables the 110 Ohm termination at the external clock connector. Only possible, when using the external connector as an input.

Minimum external sample rate

The minimum external sample rate is limited on all boards to DC and the maximum sample rate depends on the specific type of board. The maximum sample rates for your type of board are shown in the tables below.

Maximum external samplerate in MS/s

Activated channels and samplewidth		7210	7220
Ch0, 8 bit	Ch0, 16 bit		
x		10	40
	x	10	40



An external sample rate above the mentioned maximum can cause damage to the board.

Ranges for external sample rate

Due to the internal structure of the board it is essential to know for the driver in which clock range the external clock is operating. The external range register must be set according to the clock that is fed in externally.

Register	Value	Direction	Description
SPC_EXTERNRANGE	20130	read/write	Defines the range of the actual fed in external clock. Use one of the below mentioned ranges
EXRANGE_SINGLE	2		External Range Single
EXRANGE_BURST_S	4		External Range Burst S
EXRANGE_BURST_M	8		External Range Burst M
EXRANGE_BURST_L	16		External Range Burst X
EXRANGE_BURST_XL	32		External Range Burst XL



The range must not be left by more than 5 % when the board is running. Remember that the ranges depend on the activated channels as well, so a different board setup for external clocking must always include the related clock ranges.

This table below shows the ranges that are defined by the different range registers mentioned above. The range depends on the activated channels and the mode the board is used in. Please be sure to select the correct range. Otherwise it is possible that the board will not run properly.

Activated channels and samplewidth		Mode	EXRANGE_SINGLE	EXRANGE_BURST_S	EXRANGE_BURST_M	EXRANGE_BURST_L	EXRANGE_BURST_XL
Ch0 8 bit	Ch0 16 bit						
x		Standard/FIFO	< 10 MS/s		10 MS/s to max		
	x	Standard/FIFO	< 5 MS/s	5 MS/s to 10 MS/s	10 MS/s to max		

How to read this table? If you have activated channel 0 for 16 bit samplewidth and are using the board in standard mode (not FIFO) and your external clock is known to be around 8 MS/s you have to set the EXRANGE_BURST_S for the external range.

Example:

```

SpcSetParam (hDrv, SPC_CHENABLE,    MOD0_16BIT);           // activate 16 bit samplewidth
SpcSetParam (hDrv, SPC_EXTERNALCLOCK, 1);                 // activate external clock
SpcSetParam (hDrv, SPC_EXTERNRANGE, EXRANGE_BURST_S);    // set external range to Burst S

```

External clock with divider

The extra clock divider can be used to divide an external fed in clock by a fixed value. The external clock must be > 1 MS/s. This divided clock is used as a sample clock for the board.

Register	Value	Direction	Description
SPC_CLOCKDIV	20040	read/write	Extra clock divider for external samplerate. Allowed values are listed below

Available divider values

1 2 4 8 10 16 20 40 50 80 100 200
 400 500 800 1000 2000

PXI Reference Clock

Register	Value	Direction	Description
SPC_REFERENCECLOCK	20140	read/write	Programs the reference clock to either internal, external or PXI.
0			Internal reference is used for sample rate generation.
REFCLOCK_PXI	-1		PXI 10 MHz reference clock is used for sample rate generation

The 10 MHz PXI system reference clock can be used as a reference clock for internal sample rate generation. With the above mentioned software command the PXI reference clock is routed to the internal PLL. Afterwards you only have to program the sample rate register to the desired sampling rate. The remaining internal calculations will be automatically done by the driver.

Example of PXI reference clock:

```

SpcSetParam (hDrv, SPC_EXTERNALCLOCK, 0);           // Set to internal clock
SpcSetParam (hDrv, SPC_REFERENCECLOCK, REFCLOCK_PXI); // PXI Reference clock (10 MHz) used
SpcSetParam (hDrv, SPC_SAMPLERATE, 25000000);      // We want to have 25 MHz as sample rate
    
```

If you use more than one Spectrum board with the PXI reference clock source, there will be no stable phase between all the connected boards.



Trigger modes and appendant registers

General Description

Concerning the trigger modes of the Spectrum MI, MC and MX D/A boards, you can choose between three external TTL trigger modes and one internal software trigger. This chapter is about to explain the different trigger modes and setting up the board's registers for the desired mode. Every digital Spectrum board has dedicated lines in the multipin connector for feeding in an external trigger signal and for outputting a trigger signal of an external trigger event. Although two separate lines for trigger in and out are available through the multipin connector, it is not possible to output the internal software trigger event. The trigger outputs therefore can be used only if an external trigger is fed in or your digital board has additional internal trigger modes besides the software trigger. This can be used to trigger other boards or other external equipment.

Software trigger

The software trigger is the easiest way of triggering any Spectrum board. The acquisition or replay of data will start immediately after starting the board. The only delay results from the time the board needs for its setup.



Register	Value	Direction	Description
SPC_TRIGGERMODE	40000	r/w	Sets the triggermode for the board.
TM_SOFTWARE	0		Sets the trigger mode to software, so that the recording/replay starts immediately.

In addition to the softwaretrigger (free run) it is also possible to force a triggerevent by software while the board is waiting for an internal or external trigger event. Therefore you can use the board command shown in the following table.

Register	Value	Direction	Description
SPC_COMMAND	0	r/w	Command register of the board.
SPC_FORCETRIGGER	16		Forces a trigger event if the hardware is still waiting for a trigger event. Needs a base board hardware version $\geq 7.x$.

If you want to synchronize external equipment with your Spectrum board, you can additionally enable the external trigger output. As mentioned before there will be no output signal, if the internal software trigger mode is used.



Due to the structure of the digital boards the trigger output will be automatically enabled, when the external TTL trigger input is used.

Register	Value	Direction	Description
SPC_TRIGGEROUT	40100	r/w	Enables the output driver of the external trigger connector to output an internal trigger event, except the internal software trigger.
	0		The trigger output is not used and the line driver is disabled. Will be ignored, when external trigger input is used.
	1		The trigger output is used as an output that indicates a detected internal trigger event.

Example for setting up the software trigger:

```

SpcSetParam (hDrv, SPC_TRIGGERMODE, TM_SOFTWARE); // External TTL trigger mode is used
SpcSetParam (hDrv, SPC_TRIGGEROUT, 0); // And the trigger output is disabled
    
```

External TTL trigger

Enabling the external trigger input is done, if you choose one of the following external trigger modes. The dedicated register for that operation is shown below.

Register	Value	Direction	Description
SPC_TRIGGERMODE	40000	r/w	
TM_TTLPOS	20000		Sets the trigger mode for external TTL trigger to detect positive edges.
TM_TTLNEG	20010		Sets the trigger mode for external TTL trigger to detect negative edges
TM_TTLBOTH	20030		Sets the trigger mode for external TTL trigger to detect positive and negative edges

If you want to synchronize external equipment with your Spectrum board, you can additionally enable the external trigger output. As mentioned before there will be no output signal, if the internal software trigger mode is used.

Due to the structure of the digital boards the trigger output will be automatically enabled, when the external TTL trigger input is used.



Register	Value	Direction	Description
SPC_TRIGGEROUT	40100	r/w	Enables the output driver of the external trigger connector to output an internal trigger event, except the internal software trigger.
	0		The trigger output is not used and the line driver is disabled. Will be ignored, when external trigger input is used.
	1		The trigger output is used as an output that indicates a detected internal trigger event.

For the trigger input, you can decide whether it is 110 Ohm terminated or not. If you enable the termination, please make sure, that your trigger source is capable to deliver the desired current. If termination is disabled, the input is at high impedance.

Register	Value	Direction	Description
SPC_TRIGGER110OHM	40110	r/w	Sets the 110 Ohm termination, if the trigger connector is used as an input for external trigger signals.

The following short example shows how to set up the board for external positive edge TTL trigger. The trigger input is 110 Ohm terminated. The different modes for external TTL trigger are to be detailed described in the next few passages.

```

SpcSetParam (hDrv, SPC_TRIGGERMODE , TM_TTLPOS); // External positive TTL edge trigger
SpcSetParam (hDrv, SPC_TRIGGER110OHM, 1      ); // and the 110 Ohm termination of the trigger input is used
    
```

Edge triggers

Positive TTL trigger

This mode is for detecting the rising edges of an external TTL signal. The board will trigger on the first rising edge that is detected after starting the board. The next triggerevent will then be detected, if the actual recording/replay has finished and the board is armed and waiting for a trigger again.

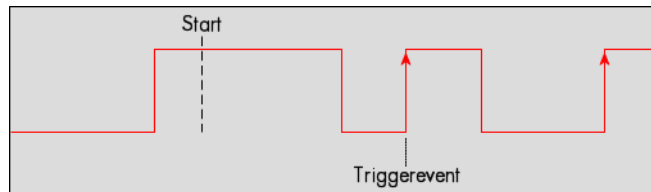

Register	Value	Direction	Description
SPC_TRIGGERMODE	40000	r/w	Sets the triggermode for the board
TM_TTLPOS	20000		Sets the trigger mode for external TTL trigger to detect positive edges

Example on how to set up the board for positive TTL trigger:

```

SpcSetParam (hDrv, SPC_TRIGGERMODE, TM_TTLPOS); // Setting up external TTL trigger to detect positive edges
    
```

Negative TTL trigger

This mode is for detecting the falling edges of an external TTL signal. The board will trigger on the first falling edge that is detected after starting the board. The next triggerevent will then be detected, if the actual recording/replay has finished and the board is armed and waiting for a trigger again.

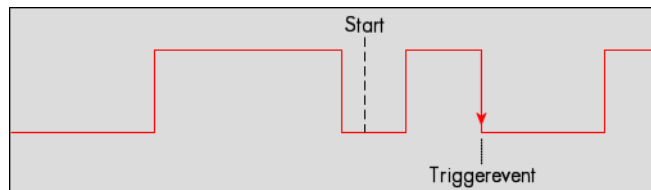

Register	Value	Direction	Description
SPC_TRIGGERMODE	40000	r/w	Sets the triggermode for the board.
TM_TTLNEG	20010		Sets the trigger mode for external TTL trigger to detect negative edges.

Positive and negative TTL trigger

This mode is for detecting the rising and falling edges of an external TTL signal. The board will trigger on the first rising or falling edge that is detected after starting the board. The next trigger-event will then be detected, if the actual recording/replay has finished and the board is armed and waiting for a trigger again.

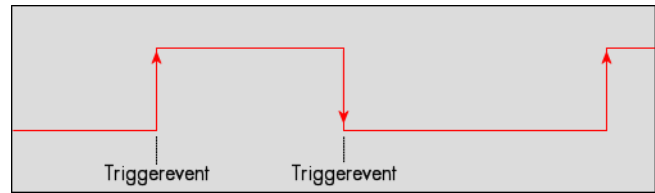

Register	Value	Direction	Description
SPC_TRIGGERMODE	40000	r/w	Sets the triggermode for the board.
TM_TTLBOTH	20030		Sets the trigger mode for external TTL trigger to detect positive and negative edges.

PXI Features

Background on PXI

PXI (PCI eXtension for instrumentation) was released as a standard based on PCI/CompactPCI bus specification and extends it by a bunch of additional lines especially designed for instrumentation purposes. PXI also has a lot of very stringent system specifications, that make sure to have a sufficient power supply and cooling power for each board. These specifications help setting up instrumentation systems and reduce the problems that might occur otherwise.

The PXI specifications are maintained and enhanced by the PXI system alliance. Spectrum is also a member of this alliance. You will find more background information on PXI on the PXI systems alliance homepage www.pxisa.org.

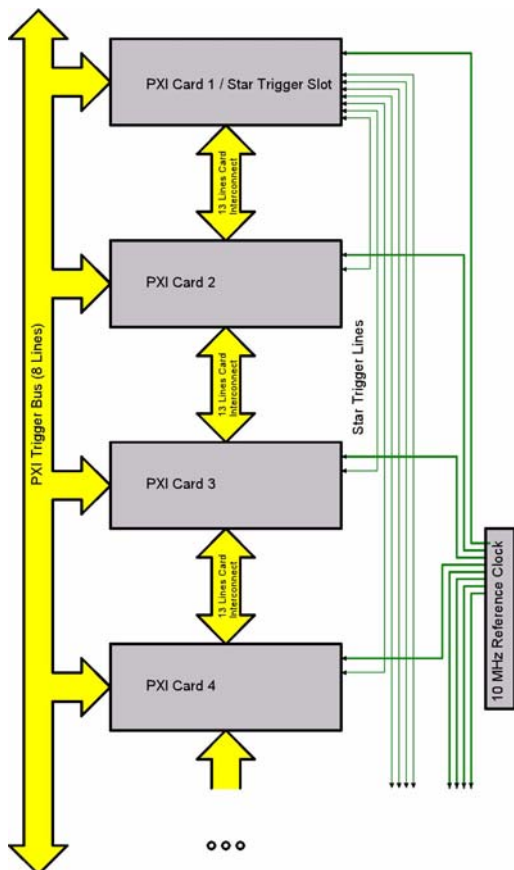

The defined additional PXI lines shown in the drawing on the left allow the easy synchronization of multiple cards without needing additional external components or cables. With some restrictions it is also possible to synchronize PXI cards from different manufacturers using the special PXI features of the boards.

As the PXI specifications do not force the manufacturers to make use of all of the features, the PXI support of cards from different manufacturers may differ a lot. Before trying to connect a Spectrum card with cards of other manufacturers please check carefully whether the PXI features match together. The Spectrum cards support all PXI features that are necessary to synchronize multiple cards. The features and the programming is explained more in detail within the following sections.

PXI and CompactPCI

PXI is an enhancement of CompactPCI. All new PXI features are located on connector lines that are not used by CompactPCI. As a result that means that a PXI card which is not using any of the PXI features behaves like a standard CompactPCI card. The Spectrum PXI cards do not rely on the PXI features and therefore can be used also in standard CompactPCI 3U systems. All features of the cards except the special PXI features can then be used without limitations.

PXI Reference Clock

The PXI reference clock is a 10 MHz square wave signal with an accuracy of 100 ppm. This reference clock is located on the PXI backplane and is routed to every PXI slot with the same trace length on the mainboard's PCB. PXI cards from Spectrum are able to use the PXI reference clock for sampling clock generation. One big advantage of using the reference clock is the fact that all cards that are synchronized to the reference clock are running with the same clock frequency.

PXI Star Trigger

One slot of the PXI system has special connections and is used as a star trigger slot. Every PXI slot is connected with a special star trigger line to this slot. Each of

these connections has the same trace length as well. When using a special star trigger card it is possible to send out a trigger pulse to every connected PXI card at the same time. Using a star trigger card together with the reference clock allows the synchronization of multiple cards with a very high accuracy. All Spectrum PXI cards support the star trigger line.

PXI Trigger Bus

In addition to the star trigger, the PXI specification also defines an 8 line trigger bus that is connected to each PXI slot. The use of this trigger bus is not specified in detail but it is mostly used to provide trigger information throughout the system. However each manufacturer can use this bus in a different way. If connecting Spectrum cards through this trigger bus with other manufacturer's boards, it is therefore extremely necessary to have a close look on how these boards are using this bus. On the Spectrum cards PXI trigger[0] to PXI trigger [5] can be individually programmed as trigger input and/or trigger output. PXI trigger[7] is used for internal purposes and may not be used by any other board when intending to use the Spectrum boards with PXI trigger.

As a PXI specification standard, these trigger lines must be in high impedance mode after powering up the system, to make sure not to destroy any components.

PXI Interconnect Bus

There's a special board-to-board interconnect bus between any two adjacent boards. These 13 lines can be used to route special analog and digital signals in between adjacent boards. The Spectrum cards do not rely upon this bus and therefore don't support it.

Programming PXI Features

This chapter shows you how to program the different PXI features that have been mentioned above. Programming the PXI features is totally independent from any other of the board’s registers. Before using any of the PXI features please make sure that the PXI-system you are operating in is supporting the desired features. There may be limitations especially when using PXI systems, that have more than 8 slots and therefore use bridge technology. Please refer to the system’s manual for more information on this.

PXI Reference Clock

Register	Value	Direction	Description
SPC_REFERENCECLOCK	20140	read/write	Programs the reference clock to either internal, external or PXI.
0			Internal reference is used for sample rate generation.
REFCLOCK_PXI	-1		PXI 10 MHz reference clock is used for sample rate generation

The 10 MHz PXI system reference clock can be used as a reference clock for internal sample rate generation. With the above mentioned software command the PXI reference clock is routed to the internal PLL. Afterwards you only have to program the sample rate register to the desired sampling rate. The remaining internal calculations will be automatically done by the driver.

Example of PXI reference clock:

```

SpcSetParam (hDrv, SPC_EXTERNALCLOCK, 0);           // Set to internal clock
SpcSetParam (hDrv, SPC_REFERENCECLOCK, REFCLOCK_PXI); // PXI Reference clock (10 MHz) used
SpcSetParam (hDrv, SPC_SAMPLERATE, 25000000);      // We want to have 25 MHz as sample rate
    
```



If you use more than one Spectrum board with the PXI reference clock source, there will be no stable phase between all the connected boards.

PXI Trigger Modes

PXI trigger is set up in two steps. Each PXI card has to be set up to use at least one of the PXI trigger lines as trigger source. Also at least one PXI card needs to be programmed to connect its internal trigger signal to one of the PXI trigger lines. The picture on the right side gives you an overview of the possible PXI trigger connections on the Spectrum cards.

Please keep in mind, that the trigger input and output via the star trigger lines can only be used, if a star trigger card is installed in the system which supports these lines.

PXI Trigger Output

One or more of the cards can be programmed to give their internally recognized trigger on one of the PXI trigger lines. The programming of the card’s trigger recognition is done in exactly the same way as described in the trigger chapter.

As soon as the PXI trigger output register is programmed, this internal trigger will not be used for triggering the card itself, but is routed to the programmed PXI line. The figure is showing all of the possible PXI trigger connections.

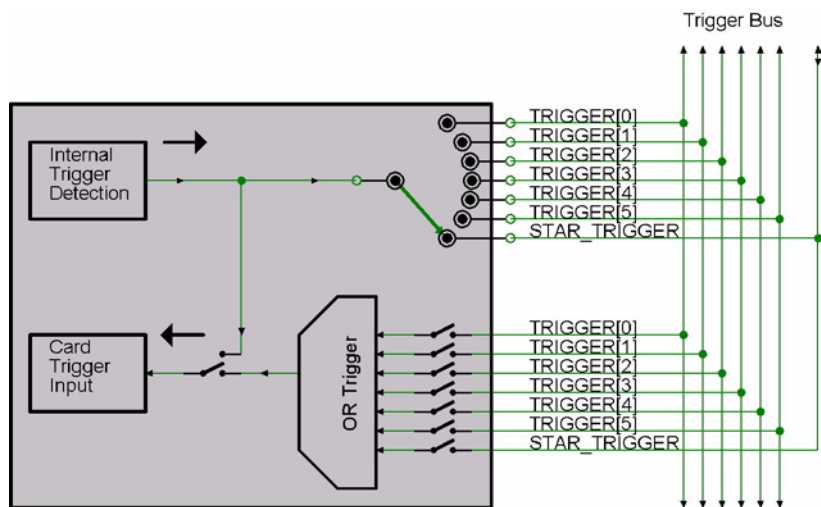

A trigger event will be indicated via the trigger lines with a rising edge, which will go back to low level at the latest when the board stops.

Register	Value	Direction	Description
SPC_PXITRGOUT	40300	r/w	Select the PXI trigger line on which the internal trigger is routed.
PTO_OFF	0		Don't route the internal trigger to a PXI trigger. Card is simply acting as slave.
PTO_LINE0	1		Route the internal trigger to PXI trigger[0]
PTO_LINE1	2		Route the internal trigger to PXI trigger[1]
PTO_LINE2	3		Route the internal trigger to PXI trigger[2]
PTO_LINE3	4		Route the internal trigger to PXI trigger[3]
PTO_LINE4	5		Route the internal trigger to PXI trigger[4]
PTO_LINE5	6		Route the internal trigger to PXI trigger[5]
PTO_LINESTAR	9		Route the internal trigger to the star trigger line. Use this way only with specially designed star trigger cards.



Be aware not to enable multiple trigger outputs on the same PXI trigger line. If two or more trigger outputs are working against each other the result is unpredictable and may even harm the hardware parts.

As one or multiple of the future PXI boards might make use of less or more than the actual seven trigger lines, there is a dedicated register, organized as a bitfield, that indicates the possible trigger output lines for the actual board.

Register	Value	Direction	Description
SPC_PXITRGOUT_AVAILABLE	40301	r	Indicates what PXI trigger lines can be used for trigger output. Only the lower two bytes are used.
	1		Trigger line 0 is available for trigger output.
	2		Trigger line 1 is available for trigger output.
	4		Trigger line 2 is available for trigger output.
	8		Trigger line 3 is available for trigger output.
	16		Trigger line 4 is available for trigger output.
	32		Trigger line 5 is available for trigger output.
	64		Trigger line 6 is available for trigger output.
	128		Trigger line 7 is available for trigger output.
	256		Star Trigger line is available for trigger output.

As mentioned in the section on PXI background, the PXI trigger line 7 is used for internal purposes. To be exact, this line is used for indicating, that the pretrigger time of every single board has passed and the board is now ready for trigger detection. All boards have an open collector output with a 4.7 kOhm pull-up resistor connected to line 7. A high level on this line then will enable the trigger detection for all the connected boards.

As the figure is showing, it is not possible to output signal coming from a PXI trigger input to any PXI trigger output. Therefore it is not possible to re-route any trigger signals.



PXI Trigger Input

Each card can react to one or multiple trigger events on the PXI bus. The trigger input must be programmed accordingly regarding the trigger outputs of the other cards that are involved in the PXI trigger setup. As the Spectrum driver cannot know which other cards from other manufacturers are involved in the PXI trigger setup, it is not able to check the correct system setup automatically.

Register	Value	Direction	Description
SPC_PXITRGIN	40310	r/w	Select the PXI trigger source that is used as an input. Multiple PXI trigger sources are OR connected. This register acts as a bitmap of the trigger sources.
PTL_OFF	0		Disables the PXI trigger input. Standard internal triggering is used.
PTL_LINE0	1		Select PXI trigger line[0] as a trigger source
PTL_LINE1	2		Select PXI trigger line[1] as a trigger source
PTL_LINE2	4		Select PXI trigger line[2] as a trigger source
PTL_LINE3	8		Select PXI trigger line[3] as a trigger source
PTL_LINE4	16		Select PXI trigger line[4] as a trigger source
PTL_LINE5	32		Select PXI trigger line[5] as a trigger source
PTL_LINESTAR	256		Select PXI star trigger line as a trigger source

As one or multiple of the future PXI boards might make use of less or more than the actual seven trigger lines, there is a dedicated register organized as a bitfield, that indicates the possible trigger input lines for the actual board.

Register	Value	Direction	Description
SPC_PXITRGIN_AVAILABLE	40311	r	Indicates what PXI trigger lines can be used for trigger input. Only the lower two bytes are used.
	1		Trigger line 0 is available for trigger input.
	2		Trigger line 1 is available for trigger input.
	4		Trigger line 2 is available for trigger input.
	8		Trigger line 3 is available for trigger input.
	16		Trigger line 4 is available for trigger input.
	32		Trigger line 5 is available for trigger input.
	64		Trigger line 6 is available for trigger input.
	128		Trigger line 7 is available for trigger input.
	256		Star Trigger line is available for trigger input.

Depending on the chosen sample rate and the used PXI slots of the trigger master and the trigger slave boards a trigger jitter of 1 sample can occur.



Example of connecting three boards, board 0 is triggering all three boards:

```

SpcSetParam (hDrv[0], SPC_TRIGGERMODE, SPC_SOFTWARE); // card 0 is used as trigger source, software trigger
SpcSetParam (hDrv[0], SPC_PXITRGOUT, PTO_LINE1); // card 0 is putting it's internal trigger on line 1

SpcSetParam (hDrv[0], SPC_PXITRGIN, PTL_LINE1); // card 0 is using PXI line 1 as trigger source
SpcSetParam (hDrv[1], SPC_PXITRGIN, PTL_LINE1); // card 1 is using PXI line 1 as trigger source
SpcSetParam (hDrv[2], SPC_PXITRGIN, PTL_LINE1); // card 2 is using PXI line 1 as trigger source
    
```

OR connecting Trigger

If the cards should react to any trigger of any other card in the system, the trigger lines can be easily combined as an OR conjunction by software. The PXI trigger input register acts as a bitmap of all possible trigger sources. Simply set all bits in the register of the trigger lines that are involved. Each card that is involved has to use a different trigger line for trigger output. As a result a maximum of 6 cards can be connected in this way.



If combining the PXI trigger OR feature with the channel trigger OR feature of the card itself one can set up systems that OR connect all trigger sources of all channels and therefore will trigger the complete system if any of the trigger events occurs. This mode is only possible when using acquisition cards.

Example of connecting three boards, all trigger sources of all boards are OR connected:

```

SpcSetParam (hDrv[0], SPC_TRIGGERMODE, SPC_TTLPOS); // card 0 is using TTL trigger with positive edge
SpcSetParam (hDrv[0], SPC_PXITRGOUT, PTO_LINE2); // card 0 is putting it's internal trigger on line 2

SpcSetParam (hDrv[1], SPC_TRIGGERMODE, SPC_TTLPOS); // card 1 is using TTL trigger with positive edge
SpcSetParam (hDrv[1], SPC_PXITRGOUT, PTO_LINE3); // card 1 is putting it's internal trigger on line 3

SpcSetParam (hDrv[2], SPC_TRIGGERMODE, SPC_TTLPOS); // card 2 is using TTL trigger with positive edge
SpcSetParam (hDrv[2], SPC_PXITRGOUT, PTO_LINE4); // card 2 is putting it's internal trigger on line 4

SpcSetParam (hDrv[0], SPC_PXITRGIN, PTI_LINE2 | PTI_LINE3 | PTI_LINE4); // All three lines as trig source
SpcSetParam (hDrv[1], SPC_PXITRGIN, PTI_LINE2 | PTI_LINE3 | PTI_LINE4); // All three lines as trig source
SpcSetParam (hDrv[2], SPC_PXITRGIN, PTI_LINE2 | PTI_LINE3 | PTI_LINE4); // All three lines as trig source

```

Option Multiple Replay

The option Multiple Replay allows the generation of data blocks with multiple trigger events without restarting the hardware. The on-board memory will be divided into several segments of the same size. Each segment will be replayed when a trigger event occurs.

Output modes

Standard Mode

With every detected trigger event one data block is replayed. The length of one Multiple Replay segment is set by the value of the posttrigger register. The total amount of samples to be replayed is defined by the memsize register.

In most cases memsize will be set to a multiple of the segment size (postcounter). The table below shows the register for enabling Multiple Replay. For detailed information on how to setup and start the standard replay mode please refer to the according chapter earlier in this manual.

Multiple Replay is not compatible with continuous output.



Register	Value	Direction	Description
SPC_MULTI	220000	r/w	Enables Multiple Replay mode.
SPC_MEMSIZE	10000	r/w	Defines the total amount of samples to be replayed.
SPC_POSTTRIGGER	10100	r/w	Defines the size of one Multiple Replay segment.

FIFO Mode

The Multiple Replay in FIFO Mode is similar to the Multiple Replay in Standard Mode. The segment size is also set by the postcounter register.

In contrast to the Standard mode you cannot programm a certain total amount of samples to be replayed. The generation is running until the user stops it. The data is transferred FIFO block by FIFO block by the driver to the board. These blocks can be online generated by the user program. This mode significantly reduces the average data transfer rate on the PCI bus. This enables you to use faster sample rates then you would be able to in FIFO mode without Multiple Replay. Usually the FIFO blocks are multiples of the Multiple Replay segments.

The advantage of Multiple Replay in FIFO mode is that you can stream data online from the host system to the board, so you can replay a huge amount of data from the hard disk. The table below shows the dedicated register for enabling Multiple Replay. For detailed information how to setup and start the board in FIFO mode please refer to the according chapter earlier in this manual.

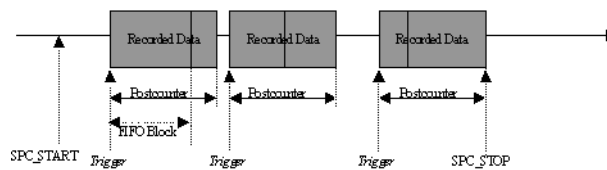

Register	Value	Direction	Description
SPC_MULTI	220000	r/w	Enables Multiple Replay mode.
SPC_POSTTRIGGER	10100	r/w	Defines the size of one Multiple Replay segment.

Trigger modes

In Multiple Replay mode all of the board's trigger modes are available except the software and pattern trigger. Depending on the different trigger modes, the chosen sample rate, used channels and activated board synchronization, (see relevant chapter for details about synchronizing multiple boards) there are different delay times between the trigger event and the first replayed data (see figure).

This internal delay is necessary as the board is equipped with dynamic RAM, which needs refresh cycles to keep the data in memory when the board is not replaying.

The delay is fixed for a certain board setup. All possible delays in samples between the trigger event and the first replayed sample are listed in the table below.

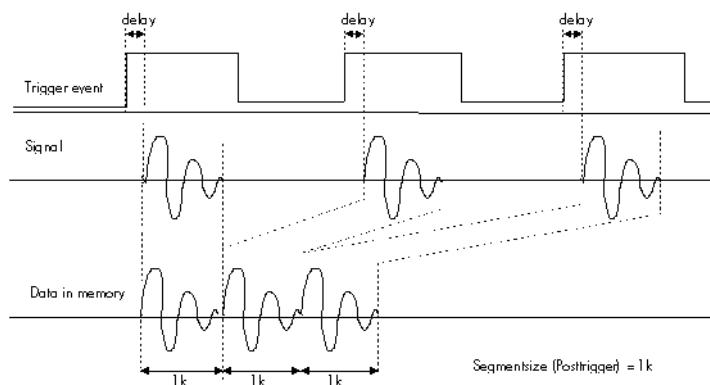

The patternttrigger modes of digital I/O boards cannot be used with multiple replay.



Resulting start delays

Sample rate	Clock source	Output Mode	Activated channels		external TTL trigger	ext. TTL trigger with activated synchronization
			Ch 0, 8 bit	Ch 0, 16 bit		
< 5 MHz	internal	Standard / FIFO	x		10 samples	11 samples
< 5 MHz	external	Standard / FIFO	x		9 samples	10 samples
≥ 5 MHz	internal / external	Standard / FIFO	x		42 samples	43 samples
< 1 MHz	internal	Standard / FIFO		x	6 samples	7 samples
1 MHz ≤ SR < 5 MHz	internal	Standard / FIFO		x	7 samples	8 samples
< 5 MHz	external	Standard / FIFO		x	6 samples	7 samples
≥ 5 MHz	internal / external	Standard / FIFO		x	23 samples	24 samples

The following example shows how to set up the board for Multiple Replay in standard mode. The setup would be similar in FIFO mode, but the memsize register would not be used.

```

SpcSetParam (hDrv, SPC_MULTI,          1);           // Enables Multiple Replay

SpcSetParam (hDrv, SPC_POSTTRIGGER,    1024);       // Set the segment size to 1024 samples
SpcSetParam (hDrv, SPC_MEMSIZE,        4096);       // Set the total memsize for replaying to 4096 samples
                                                    // so that actually four segments will be replayed

SpcSetParam (hDrv, SPC_TRIGGERMODE,    TM_TTLPOS);  // Set the triggermode to external TTL mode (rising edge)

```

Option Gated Replay

The option Gated Replay allows the data generation controlled by an external gate signal. Data will only be output, if the programmed gate condition is true.

Output modes

Standard Mode

Data will be replayed as long as the gate signal fulfills the gate condition that has had to be programmed before. At the end of the gate interval the replay will be stopped and the board will pause until another gates condition is detected. If the total amount of data to replay has been reached the board stops immediately (see figure). The total amount of samples to be replayed can be defined by the memsize register. The table below shows the register for enabling Gated Replay. For detailed information on how to setup and start the standard generation mode please refer to the relevant chapter earlier in this manual.

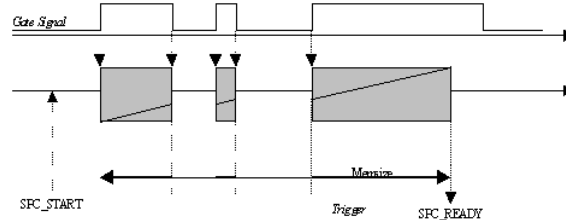

Register	Value	Direction	Description
SPC_GATE	220400	r/w	Enables Gated Replay mode.
SPC_MEMSIZE	10000	r/w	Defines the total amount of samples to replay.

FIFO Mode

The Gated Replay in FIFO Mode is similar to the Gated Replay in Standard Mode. In contrast to the Standard mode you cannot program a certain total amount of samples to be replayed. The generation is running until the user stops it. The data is transferred to the board FIFO block by FIFO block by the driver. These blocks can be online generated by the user program. The advantage of Gated Replay in FIFO mode is that you can stream data online from the host system to the board, so you can replay a huge amount of data from the hard disk with a lower average data rate than in conventional FIFO mode. The table below shows the dedicated register for enabling Gated Replay. For detailed information how to setup and start the board in FIFO mode please refer to the according chapter earlier in this manual.

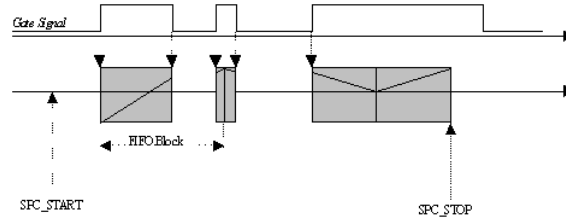

Register	Value	Direction	Description
SPC_GATE	220400	r/w	Enables Gated Replay mode.

Trigger modes

General information and trigger delay

Not all of the board's trigger modes can be used in combination with Gated Replay. All possible trigger modes are listed below. Depending on the different trigger modes, the chosen sample rate, the used channels and activated board synchronization (see according chapter for details about synchronizing multiple boards) there are different delay times between the trigger event and the first replayed sample (see figure). This start delay is necessary as the board is equipped with dynamic RAM, which needs refresh cycles to keep the data in memory when the board is not replaying. It is fix for a certain board setup.

All possible start delays in samples between the trigger event and the first replayed sample are listed in the table below.

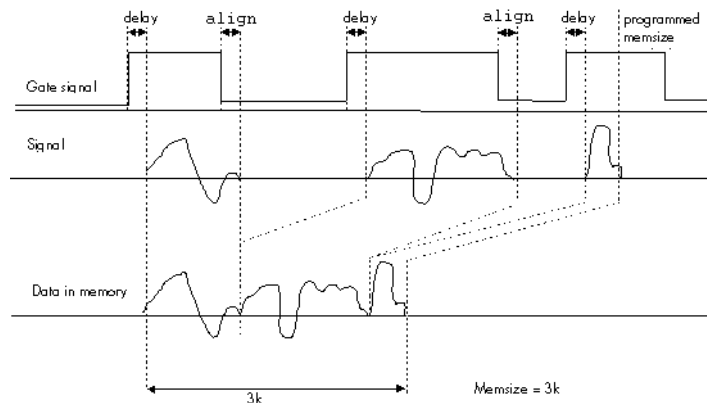

Due to the structure of the on-board memory there is another delay at the end of the gate interval.

Internally a gate-end signal can only be recognized at an eight samples alignment.

So depending on what time your external gate signal will leave the programmed gate condition it might happen that at maximum seven more samples are replayed, before the board pauses (see figure).

The figure on the right is showing this end delay exemplarily for three possible gate signals. As all samples are counted from zero. The eight samples alignment in the upper two cases is reached at the end of sample 39, which is therefore the 40th sample.

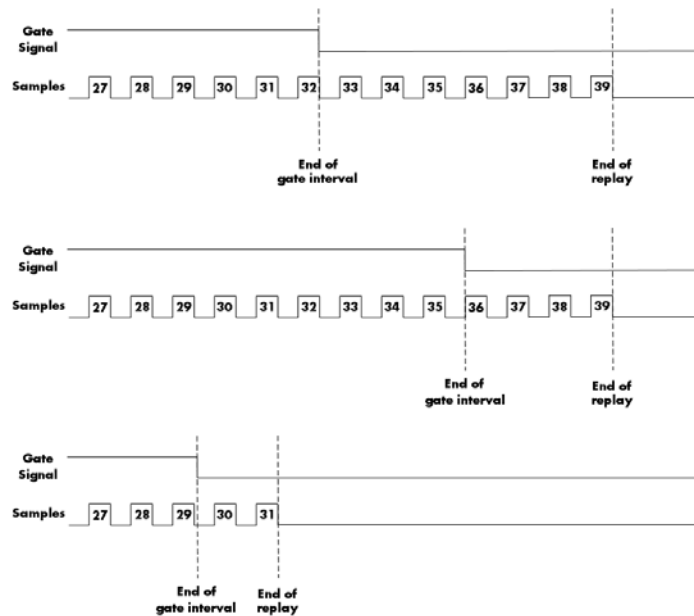

Alignement samples per channel

As described above there's an alignment at the end of the gate signal. The alignment depends on the used mode (standard or FIFO) and the selected channels. Please refer to this table to see how many samples per channel of alignment one gets.

Module 0		Mode	Alignment
8 bit	16 bit		
X		Standard/FIFO	16 samples
	X	Standard/FIFO	8 samples

Resulting start delays

Sample rate	Clock source	Output Mode	Activated channels		external TTL trigger	ext. TTL trigger with activated synchronization
			Ch 0, 8 bit	Ch 0, 16 bit		
< 5 MHz	internal	Standard / FIFO	x		10 samples	11 samples
< 5 MHz	external	Standard / FIFO	x		9 samples	10 samples
≥ 5 MHz	internal / external	Standard / FIFO	x		42 samples	43 samples
< 1 MHz	internal	Standard / FIFO		x	6 samples	7 samples
1 MHz ≤ SR < 5 MHz	internal	Standard / FIFO		x	7 samples	8 samples
< 5 MHz	external	Standard / FIFO		x	6 samples	7 samples
≥ 5 MHz	internal / external	Standard / FIFO		x	23 samples	24 samples

Number of samples on gate signal

As described above there's a delay at the start of the gate interval due to the internal memory structure. However this delay can be partly compensated by internal pipelines resulting in a data delay that even can be negative showing the trigger event (acquisition mode only). This data delay is listed in an extra table. But beneath this compensation there's still the start delay that as a result causes the card to use less samples than the gate signal length. Please refer to the following table to see how many samples less than the length of gate signal are used

Module 0		Mode	Sampling clock		less samples	
8 bit	16 bit		< 10 MS/s	≥ 10 MS/s	< 5 MS/s	≥ 5 MS/s
X		Standard/FIFO	< 10 MS/s	≥ 10 MS/s	14	24
	X	Standard/FIFO	< 5 MS/s	≥ 5 MS/s	7	12

Allowed trigger modes

As mentioned above not all of the possible trigger modes can be used as a gate condition. The following table is showing the allowed trigger modes that can be used and explains the event that has to be detected for gate-start end for gate-end.

External TTL edge trigger

Mode	Gate start will be detected on	Gate end will be detected on
TM_TTLPOS	positive edge on external trigger	negative edge on external trigger
TM_TTL_NEG	negative edge on external trigger	positive edge on external trigger

Example program

The following example shows how to set up the board for Gated Replay in standard mode. The setup would be similar in FIFO mode, but the memsize register would not be used.

```

SpcSetParam (hDrv, SPC_GATE,          1);           // Enables Gated Replay
SpcSetParam (hDrv, SPC_MEMSIZE,      4096);        // Set the total memsize of generation to 4096 samples
SpcSetParam (hDrv, SPC_TRIGGERMODE,  TM_TTLPOS);   // Sets the gate condition to external TTL mode, so that
                                                    // data is replayed, if the signal is at HIGH level

```

Appendix

Error Codes

The following error codes could occur when a driver function has been called. Please check carefully the allowed setup for the register and change the settings to run the program.

error name	value (hex)	value (dec.)	error description
ERR_OK	0h	0	Execution OK, no error.
ERR_INIT	1h	1	The board number is not in the range of 0 to 15. When initialisation is executed: the board number is yet initialised, the old definition will be used.
ERR_NR	2h	2	The board is not initialised yet. Use the function SpcInItPCIBoards first. If using ISA boards the function SpcInItBoard must be called first.
ERR_TYP	3h	3	Initialisation only: The type of board is unknown. This is a critical error. Please check whether the board is correctly plug in the slot and whether you have the latest driver version.
ERR_FNCNOTSUPPORTED	4h	4	This function is not supported by the hardware version.
ERR_BRDREMAP	5h	5	The board index remap table in the registry is wrong. Either delete this table or check it carefully for double values.
ERR_KERNELVERSION	6h	6	The version of the kernel driver is not matching the version of the DLL. Please do a complete reinstallation of the hardware driver. This error normally only occurs if someone copies the dll manually to the system directory.
ERR_HWDRVVERSION	7h	7	The hardware needs a newer driver version to run properly. Please install the driver that was delivered together with the board.
ERR_ADDRANGE	8h	8	The address range is disabled (fatal error)
ERR_LASTERR	10h	16	Old Error waiting to be read. Please read the full error information before proceeding. The driver is locked until the error information has been read.
ERR_ABORT	20h	32	Abort of wait function. This return value just tells that the function has been aborted from another thread.
ERR_BOARDLOCKED	30h	48	Access to the driver already locked by another program. Stop the other program before starting this one. Only one program can access the driver at the time.
ERR_REG	100h	256	The register is not valid for this type of board.
ERR_VALUE	101h	257	The value for this register is not in a valid range. The allowed values and ranges are listed in the board specific documentation.
ERR_FEATURE	102h	258	Feature (option) is not installed on this board. It's not possible to access this feature if it's not installed.
ERR_SEQUENCE	103h	259	Channel sequence is not allowed.
ERR_READABORT	104h	260	Data read is not allowed after aborting the data acquisition.
ERR_NOACCESS	105h	261	Access to this register denied. No access for user allowed.
ERR_POWERDOWN	106h	262	Not allowed if powerdown mode is activated.
ERR_TIMEOUT	107h	263	A timeout occurred while waiting for an interrupt. Why this happens depends on the application. Please check whether the timeout value is programmed too small.
ERR_CHANNEL	110h	272	The channel number may not be accessed on the board: Either it is not a valid channel number or the channel is not accessible due to the actual setup (e.g. Only channel 0 is accessible in interlace mode)
ERR_RUNNING	120h	288	The board is still running, this function is not available now or this register is not accessible now.
ERR_ADJUST	130h	304	Automatic adjustment has reported an error. Please check the boards inputs.
ERR_NOPCI	200h	512	No PCI BIOS is found on the system.
ERR_PCIVERSION	201h	513	The PCI bus has the wrong version. SPECTRUM PCI boards require PCI revision 2.1 or higher.
ERR_PCINOBOARDS	202h	514	No SPECTRUM PCI boards found. If you have a PCI board in your system please check whether it is correctly plug into the slot connector and whether you have the latest driver version.
ERR_PCICHECKSUM	203h	515	The checksum of the board information has failed. This could be a critical hardware failure. Restart the system and check the connection of the board in the slot.
ERR_DMALOCKED	204h	516	DMA buffer not available now.
ERR_MEMALLOC	205h	517	Internal memory allocation failed. Please restart the system and be sure that there is enough free memory.
ERR_FIFOBUFOVERRUN	300h	768	Driver buffer overrun in FIFO mode. The hardware and the driver have been fast enough but the application software didn't manage to transfer the buffers in time.
ERR_FIFOHWOVERRUN	301h	769	Hardware buffer overrun in FIFO mode. The hardware transfer and the driver has not been fast enough. Please check the system for bottlenecks and make sure that the driver thread has enough time to transfer data.
ERR_FIFOFINISHED	302h	770	FIFO transfer has been finished, programmed number of buffers has been transferred.
ERR_FIFOSETUP	309h	777	FIFO setup not possible, transfer rate to high (max 250 MB/s).
ERR_TIMESTAMP_SYNC	310h	784	Synchronisation to external timestamp reference clock failed. At initialisation is checked whether there is a clock edge present at the input.
ERR_STARHUB	320h	800	The autorouting function of the star-hub initialisation has failed. Please check whether all cables are mounted correctly.

Pin assignment of the multipin connector

The 40 lead multipin connector is used for the additional digital inputs (on analog acquisition boards only) or additional digital outputs (on analog generation boards only).

The connector mentioned here is either mounted on the bracket of a digital I/O board or on an extra bracket.

The pin assignment is given in the table below.

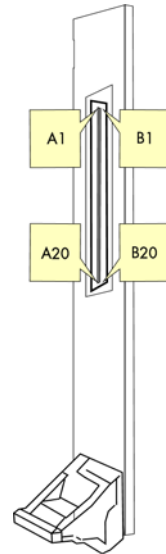

Main digital outputs

Channel 0:

B1	B2	B3	B4	B5	B6	B7	B8	B9	B10	B11	B12	B13	B14	B15	B16	B17	B18	B19	B20
D8	GND	D9	GND	D10	GND	D11	GND	D12	GND	D13	GND	D14	GND	D15	GND	Trigger in	GND	Clock in	GND

A1	A2	A3	A4	A5	A6	A7	A8	A9	A10	A11	A12	A13	A14	A15	A16	A17	A18	A19	A20
D0	GND	D1	GND	D2	GND	D3	GND	D4	GND	D5	GND	D6	GND	D7	GND	Trigger out	GND	Clock out	GND

Pin assignment of the multipin cable

The 40 lead multipin cable is used for the additional digital inputs (on analog acquisition boards only) or additional digital outputs (on analog generation boards only) as well as for the digital I/O or pattern generator boards.

The flat ribbon cable is shipped with the boards that are equipped with one or more of the above mentioned options. The cable ends are assembled with two standard 20 pole IDC socket connector so you can easily make connections to your type of equipment or DUT (device under test).

The pin assignment is given in the table in the according chapter of the appendix.

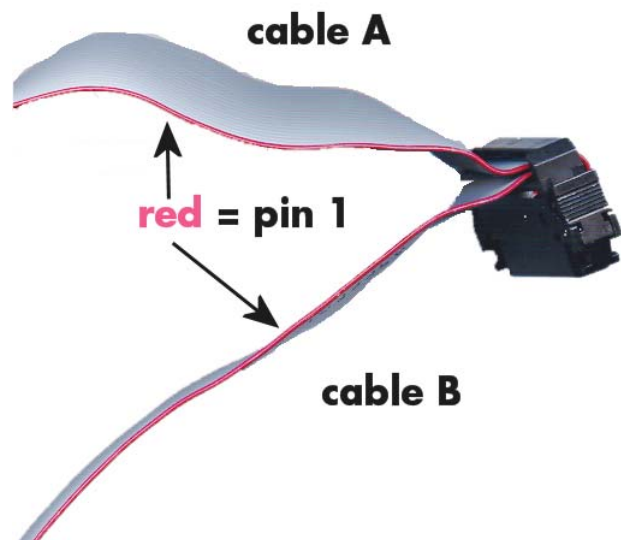

IDC footprints

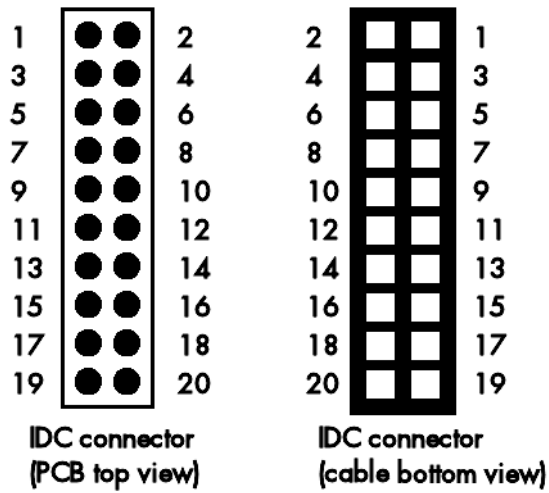

The 20 pole IDC connectors have the following footprints. For easy usage in your PCB the cable footprint as well as the PCB top footprint are shown here. Please note that the PCB footprint is given as top view.



The following table shows the relation between the card connector pin and the IDC pin:

IDC footprint pin	Card connector pin
1	A1, A21, A41, A61, B1, B21, B41 or B61
3	A3, A23, A43, A63, B3, B23, B43 or B63
5	A5, A25, A45, A65, B5, B25, B45 or B65
7	A7, A27, A47, A67, B7, B27, B47 or B67
9	A9, A29, A49, A69, B9, B29, B49 or B69
11	A9, A29, A49, A69, B9, B29, B49 or B69
13	A13, A33, A53, A73, B13, B33, B53 or B73
15	A15, A35, A55, A75, B15, B35, B55 or B75
17	A17, A37, A57, A77, B17, B37, B57 or B77
19	A19, A39, A59, A79, B19, B39, B59 or B79

Card connector pin	IDC footprint pin
A2, A22, A42, A62, B2, B22, B42 or B62	2
A4, A24, A44, A64, B4, B24, B44 or B64	4
A6, A26, A46, A66, B6, B26, B46 or B66	6
A8, A28, A48, A68, B8, B28, B48 or B68	8
A10, A30, A50, A70, B10, B30, B50 or B70	10
A12, A32, A52, A72, B12, B32, B52 or B72	12
A14, A34, A54, A74, B14, B34, B54 or B74	14
A16, A36, A56, A76, B16, B36, B56 or B76	16
A18, A38, A58, A78, B18, B38, B58 or B78	18
A20, A40, A60, A80, B20, B40, B60 or B80	20