



SPECTRUM

SYSTEMENTWICKLUNG MICROELECTRONIC GMBH

M2i.60xx - 14 bit 125 MS/s Arbitrary Waveform Generator

- **Fast 14 bit arbitrary waveform generator**
- **1, 2 or 4 channels with 20 MS/s, 60 MS/s or 125 MS/s**
- **Simultaneous generation on all channels**
- **Output up to ± 3 V in 50 Ohm**
- **Amplifier option available for ± 10 V**
- **Offset and amplitude programmable**
- **3 software selectable filters**
- **Up to 2 GSamples on-board memory**
- **128 MSample standard memory installed**
- **FIFO mode continuous streaming output**
- **Synchronization of up to 16 cards per system and up to 271 cards with system sync**
- **Options: Multiple Replay, Gated Replay, BaseXIO, Digital Outputs, Amplifier**

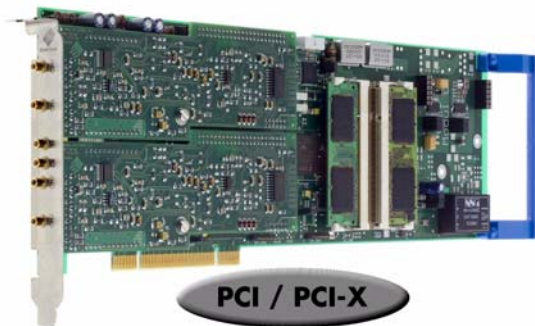

PCI / PCI-X

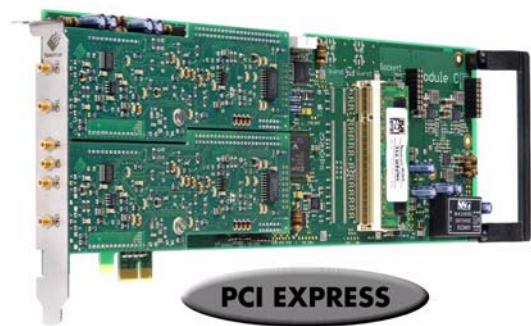

PCI EXPRESS

- 66 MHz 32 bit PCI-X interface
- 5V / 3.3V PCI compatible
- 100% compatible to conventional PCI > V2.1
- Sustained streaming mode up to 245 MB/s

- 2,5 GBit x1 PCIe Interface
- Works with x1/x4/x8/x16* PCIe slots
- Software compatible to PCI
- Sustained streaming mode up to 160 MB/s

Operating Systems

- Windows 2k, XP, Vista, 7
- Linux Kernel 2.4 + 2.6
- Windows/Linux 32 and 64 bit

Recommended Software

- Visual Basic, Visual C++, Borland C++ Builder, GNU C++, Borland Delphi, .VB.NET, C#, J#, Python
- SBench 6

Drivers

- MATLAB
- LabVIEW, LabWindows
- DASYLab
- Agilent VEE

Model	1 channel	2 channels	4 channels
M2i.6011	20 MS/s	20 MS/s	
M2i.6012	20 MS/s	20 MS/s	20 MS/s
M2i.6021	60 MS/s	60 MS/s	
M2i.6022	60 MS/s	60 MS/s	60 MS/s
M2i.6030	125 MS/s		
M2i.6031	125 MS/s	125 MS/s	
M2i.6033	125 MS/s	62.5 MS/s	
M2i.6034	125 MS/s	125 MS/s	62.5 MS/s

General Information

The M2i.60xx series offers 8 different versions of arbitrary waveform generators for the PCI/PCI-X bus and PCI Express. With these boards it is possible to generate free definable waveforms on several channels synchronously. With one of the synchronization options the setup of synchronous multi channel systems is possible. It is also possible to combine the arbitrary waveform generator with other boards of the M2i product family like analog acquisition or digital I/O boards. With the up to 2 GSamples on-board memory long waveforms can be generated even with high sampling rates. All boards of the M2i.60xx series may use the whole installed on-board memory completely for the currently activated number of channels. The memory can also be used as a FIFO buffer to make continuously data transfer from PC memory or hard disk.

*Some x16 PCIe slots are for the use of graphic cards only and can not be used for other cards.

Software Support

Windows drivers

The cards are delivered with drivers for Windows 2000, XP, XP64, Vista and Vista64 as well as Windows 7. Programming examples for Visual C++, Borland C++ Builder, LabWindows/CVI, Borland Delphi, Visual Basic, VB.NET, C# and J# are included.

Linux Drivers



All cards are delivered with full Linux support. Pre compiled kernel modules are included for the most common distributions like RedHat, Fedora, Suse or Debian. The Linux support includes SMP systems, 32 bit and 64 bit systems, versatile programming examples for Gnu C++ as well as the possibility to get the driver sources for own compilation.

SPEasyGenerator



For a fast start with the hardware the simple signal generation software SPEasyGenerator is included in the delivery. This software allows to generate simple signal shapes like sine, triangle or rectangle with programmable frequency, amplitude and phase. SPEasy-

Generator is also available as LabWindows source code.

SBench

A full licence of SBench the easy-to-use graphical operating software for the Spectrum cards is included in the delivery. The version 6 is running under Windows as well as under Linux (KDE and GNOME).

Third-party products

A lot of third-party products are supported as an option. Choose between LabVIEW, MATLAB, DASyLab and Agilent VEE. All drivers come with examples and detailed documentation.

MI Software compatibility layer

To allow an easy change from MI cards to the new M2i cards for existing software a special software compatibility layer is delivered with the cards. This DLL converts MI calls to M2i calls and simulates a MI card in the software.

Hardware features and options

PCI/PCI-X



The cards with PCI/PCI-X bus connector use 32 Bit and up to 66 MHz clock rate for data transfer. They are 100% compatible to Conventional PCI > V2.1. The universal interface allows the use in PCI slots with 5 V I/O and 3.3 V I/O voltages as well as in PCI-

X or PCI 64 slots. The maximum sustained data transfer rate is 245 MByte/s per bus segment.

PCI Express



The cards with PCI Express use a x1 PCIe connector. They can be used in PCI Express x1/x4/x8/x16 slots, except special graphic card slots, and are 100% software compatible to Conventional PCI > V2.1. The maximum sustained data transfer rate is

160 MByte/s per slot.

FIFO mode

The FIFO mode is designed for continuous data transfer between measurement board and PC memory or hard disk. The control of the data stream is done automatically by the driver on interrupt request. The complete installed on-board memory is used for buffer data, making the continuous streaming extremely reliable.

External trigger I/O

All digital boards can be triggered using an additional external TTL signal per acquisition module. It's possible to use positive or negative edge also in combination with a programmable pulse width. An internally recognized trigger event can - when activated by software - be routed to the trigger output connector to start external instruments.

Pulse width

Defines the minimum or maximum width that a trigger pulse must have to generate a trigger event. Pulse width can be combined with channel trigger, pattern trigger and external trigger.

Multiple Replay

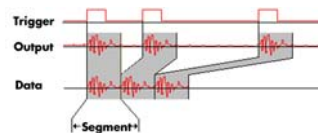

The Multiple Replay option allows the fast repetition output on several trigger events without restarting the hardware. With this option very fast repetition rates can be achieved.

The on-board memory is divided in several segments of same size. Each of them is generated if a trigger event occurs.

Gated Replay

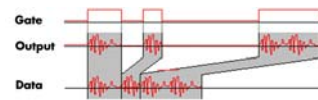

The Gated Sampling option allows data replay controlled by an external gate signal. Data is only replayed if the gate signal has a pro-

grammed level.

Option Sequence Mode

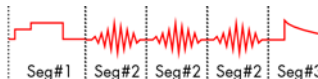

The sequence mode option allows to split the card memory into

several data segments of different length. These data segments are chained up in a user chosen order using an additional sequence step memory. In this sequence memory the number of loops for each segment can be programmed and trigger conditions can be defined to proceed from step to step. Using the sequence mode it is also possible to switch between replay waveforms by simple software command or to redefine waveform data for segments simultaneously while other segments are replayed.

Digital outputs

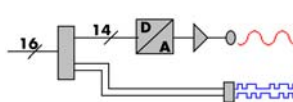

This option outputs additional synchronous digital channels phase-stable with the analog data. When this option is installed there are 2 additional digital outputs for every analog D/A channel.

External clock I/O

Using a dedicated line a sampling clock can be fed in from an external system. It's also possible to output the internally used sampling clock to synchronize external equipment to this clock.

Reference clock

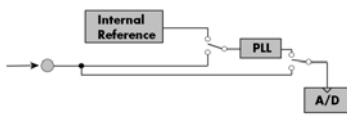

The option to use a precise external reference clock (normally 10 MHz) is necessary to synchronize the board for high-quality measurements with external equipment (like a signal source). It's also possible to enhance the quality of the sampling clock in this way. The driver automatically generates the requested sampling clock from the fed in reference clock.

Singleshot output

When singleshot output is activated the data of the on-board memory is replayed exactly one time. As trigger source one can use the external TTL trigger or the software trigger.

Repeated output

When repeated output is used the data of the on-board memory is replayed continuously until a stop command is executed or N times. As trigger source one can use the external TTL trigger or the software trigger.

Single Restart replay

When this mode is activated the data of the on-board memory will be replayed once after each trigger event. Trigger source one can use the external TTL or software trigger.

±10 V Amplifier



The amplifier board allows the output of ± 10 V on up to four channels without software modification. The standard outputs of the card are amplified by factor 3.33. The amplifier which has 30 MHz bandwidth has an output impedance of 50 Ohm. This allows ± 10 V with high impedance termination or ± 5 V with 50 ohm termination.

Star-Hub



The star-hub is an additional module allowing the phase stable synchronisation of up to 16 boards in one system. Independent of the number of boards there is no phase delay between all channels. The star-hub distributes trigger and

clock information between all boards. As a result all connected boards are running with the same clock and the same trigger. All trigger sources can be combined with OR/AND allowing all channels of all cards to be trigger source at the same time. The star-hub is available as 5 card and 16 card version. The 5 card version doesn't need an extra slot.

271 synchronous cards with the System Star-Hub

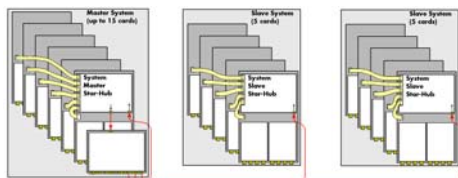

With the help of multiple system star-hubs it is possible to link up to 17 system phase synchronous with each other.

Each system can then contain up to 16 cards (master only 15). In total 271 cards can be used fully synchronously in a bunch of systems. One master system distributes clock and trigger signal to all connected slave systems.

BaseXIO (enhanced trigger)



The BaseXIO option offers 8 asynchronous digital I/O lines on the base card. The direction can be selected by software in groups of four. Two of these lines can also be used as additional external trigger sources. This allows the building of complex trigger conjunctions with external gated triggers as well as AND/OR conjunction of multiple external trigger sources like, for example, the picture and row synchronisation of video signals. In addition one of the I/O lines can be used as reference clock for the Timestamp counter.

Technical Data

Analog Outputs

Resolution	14 bit
INL, Integral linearity (DAC only)	± 1.5 LSB typ.
DNL, Differential linearity (DAC only)	± 1.0 LSB typ.
Output resistance	< 1 Ohm
Minimum output load	35 Ohm (not short circuit protected)
Max output swing in 50 Ohm	± 3 V (offset + amplitude)
Max slew rate (no filter)	> 0.9 V/ns
Crosstalk @ 1 MHz signal ±3 V	< -80 dB
Output accuracy	< 1%
Connector (analog and trigger/clock)	3 mm SMB male

Trigger

Multi, Gate: re-arming time	<4 Samples
Trigger output delay	One positive edge after internal trigger event
External trigger type	3.3V LVTTTL compatible (5V tolerant)
External trigger input	Low ≤ 0.8 V, High ≥ 2.0 V, ≥ 8 ns in pulse stretch mode, ≥ 2 clock periods all other modes
External trigger maximum voltage	-0.5 V up to +5.7 V (internally clamped to 5.0V, 100 mA max. clamping current)
External trigger output levels	Low ≤ 0.4 V, High ≥ 2.4 V, TTL compatible
External trigger output drive strength	Capable of driving 50 ohm load

Environmental and Physical details

Dimension (PCB only)	312 mm x 107 mm (full PCI length)
Width (Standard or star-hub 5)	1 full size slot
Width (star-hub 16)	2 full size slots
Width (with digital inputs)	1 full size slots + 1 half size slot
Weight (depending on options/channels)	290g (2 ch) up to 460g (4 ch + dig + sh)
Warm up time	10 minutes
Operating temperature	0°C - 50°C
Storage temperature	-10°C - 70°C
Humidity	10% to 90%

PCI / PCI-X specific details

PCI / PCI-X bus slot type	32 bit 33/66 MHz
PCI / PCI-X bus slot compatibility	32/64 bit, 33-133 MHz, 3,3 V and 5 V I/O

PCI EXPRESS specific details

PCIe slot type	x1
PCIe slot compatibility	x1/x4/x8/x16*

*Some x16 PCIe slots are for graphic cards only and can not be used for other cards.

Max channels with Star-Hub	SH5	SH16	SSH55	SSH516
M2i.6030	5	16	85	271
M2i.60x1, 60x3	10	32	170	542
M2i.60x2, 60x4	20	64	340	1084

Power consumption (max speed)	PCI / PCI-X		PCI EXPRESS	
	3,3 V	5 V	3,3 V	12 V
M2i.6030 (128 MS memory)	2.6 A	0.4 A	0.4 A	0.9 A
M2i.60x1/M2i.60x3 (128 MS mem.)	2.8 A	0.7 A	0.4 A	1.1 A
M2i.60x2/M2i.60x4 (128 MS mem.)	3.2 A	1.1 A	0.4 A	1.2 A
M2i.6034 (2 GS memory), max. power	4.9 A	1.1 A	0.4 A	1.7 A

Certifications, Compliances, Warranty

EMC Immunity	Compliant with CE Mark
EMC Emission	Compliant with CE Mark
Product warranty	2 years starting with the day of delivery
Software and firmware updates	Life-time, free of charge
MTBF	100000 hours

Amplifier Option

Power consumption	3,3 V	5 V
1 Channel version	0.0 A	2.5 A
2 Channel version	0.0 A	2.5 A
5 Channel version	0.0 A	5.0 A
Gain Error	≤ ±1 %	
Offset Error	≤ ±50 mV	

Clock

Internal clock range (PLL mode)	1 kS/s to max (see table below)
Internal clock accuracy	20 ppm
Internal clock: max. jitter in PLL mode	TBD
Internal clock: max. jitter in quartz mode	TBD
Internal clock setup granularity (≤ 100 M)	≤1% of range (100M, 10M, 1M, 100k,...)
Internal clock setup granularity example	range 1M to 10M: stepsize ≤ 100k
Reference clock: external clock range	≥ 1.0 MHz and ≤ 125.0 MHz
External clock range	DC to max (see table below)
External clock delay to internal clock	5.4 ns
External clock type	3.3V LVTTTL compatible
External clock input	Low ≤ 0.8 V, High ≥ 2.0 V, duty 45% - 55%
External clock maximum voltage	-0.5 V up to +3.8 V (internally clamped to 3.3V, 100 mA max. clamping current)
External clock output levels	Low ≤ 0.4 V, High ≥ 2.4 V, TTL compatible
External clock output drive strength	Capable of driving 50 ohm load

Digital Outputs (Option)

Digital outputs delay to analog sample	no delay
Output voltage	Low ≤ 0.4 V, High ≥ 2.4 V
Connector (digital outputs)	40 pole half pitch (Hirose FX2 series)

Output Delays

Trigger to 1st sample	15/16 clocks (2/1 channel/module)
Gate end to last replayed sample	15/16 clocks (2/1 channel/module)
Gate end alignment	2 samples (1 ch), 1 sample (2 or 4 ch)

BaseXIO (Option)

BaseXIO Connector (extra bracket)	8 x SMB (8 x MMCX internal)
BaseXIO input	TTL compatible: Low ≤ 0.8 V, High ≥ 2.0 V
BaseXIO input maximum voltage	-0.5 V up to +4.0 V (internally clamped to 3.3V, 100 mA max. clamping current)
BaseXIO input impedance	4.7 kOhm towards 3.3 V
BaseXIO output levels	TTL compatible: Low ≤ 0.4 V, High ≥ 2.4 V
BaseXIO output drive strength	32 mA maximum current

Software programmable parameters

Output amplitude	±100 mV up to ±3 V in 1 mV steps (Amp option: ±333 mV up to ±10 V)
Output offset	±3 V selectable in 1 mV steps (Amp option: ±10 V in 3 mV steps)
Filters	no filter or one of 3 different filters as defined in technical data section
Mode	Singleshot, Repeated Replay, Single Restart
Clock mode	Int. PLL, int. quartz, ext. clock, ext. divided, ext. reference clock, sync
Clock impedance	50 Ohm / high impedance (> 4kOhm)
Trigger impedance	50 Ohm / high impedance (> 4kOhm)
Trigger mode	external TTL, software, pulsewidth, Or/And, Delay
Trigger edge	Rising edge, falling edge, both edges
Trigger pulse width	0 to [64k - 1] samples in steps of 1 sample
Trigger delay	0 to [64k - 1] samples in steps of 1 sample
Memory depth	8 up to [installed memory / number of active channels] in steps of 4
Multiple Replay segment size	8 up to [installed memory / 2 / active channels] in steps of 4
Sync clock divider	2 up to [8k - 2] in steps of 2
Channel selection	1, 2, 4

Number of amplified channels	1, 2 or 4
Max. input voltage	±3 V
Output impedance	50 Ohm
Max. Output Voltage (into high impedance load)	±10 V
Max. Output Voltage (into 50 Ohm load)	±5 V
Analog ground to PC system ground impedance	10 kOhm (with ground jumper unplugged)
	0 Ohm (when ground jumper is plugged)

Clock and Filter

	M2i.6011 M2i.6012	M2i.6021 M2i.6022	M2i.6030 M2i.6033	M2i.6031 M2i.6034
max internal clock	20 MS/s	62.5 MS/s	125 MS/s	125 MS/s
max external clock	20 MS/s	62.5 MS/s	125 MS/s	125 MS/s
-3 dB bandwidth no filter	> 10 MHz	> 30 MHz	> 60 MHz	> 60 MHz
Filter 3: Characteristics	4th order Butterworth		5th order Butterworth	
Filter 3: -3 dB bandwidth	5 MHz	10 MHz	25 MHz	25 MHz
Filter 2: Characteristics	4th order Butterworth		4th order Butterworth	
Filter 2: -3 dB bandwidth	1 MHz	2 MHz	5 MHz	5 MHz
Filter 1: Characteristics	4th order Butterworth		4th order Butterworth	
Filter 1: -3 dB bandwidth	100 kHz	200 kHz	500 kHz	500 kHz

Dynamic Parameters

	M2i.6011 M2i.6012	M2i.6011 M2i.6012	M2i.6011 M2i.6012	M2i.6021 M2i.6022	M2i.6021 M2i.6022	M2i.6030 M2i.6031 M2i.6033 M2i.6034	M2i.6030 M2i.6031 M2i.6033 M2i.6034	M2i.6030 M2i.6031 M2i.6033 M2i.6034	M2i.6030 M2i.6031 M2i.6033 M2i.6034
Test - Samplerate	20 MS/s	20 MS/s	20 MS/s	60 MS/s	60 MS/s	62.5 MS/s	62.5 MS/s	125 MS/s	125 MS/s
Output Frequency	80 kHz	800 kHz	4 MHz	170 kHz	1.7 MHz	400 kHz	4 MHz	400 kHz	4 MHz
Output Level	±2 V	±2 V	±2 V	±2 V	±2 V	±2 V	±2 V	±2 V	±2 V
Used Filter	100 kHz	1 MHz	5 MHz	200 kHz	2 MHz	500 kHz	5 MHz	500 kHz	5 MHz
SNR (typ)	> 61.5 dB	> 60.2 dB	> 54.5 dB	> 61.5 dB	> 59.5 dB	> 61.5 dB	> 55.0 dB	> 61.0 dB	> 56.0 dB
THD (typ)	< -70.4 dB	< -67.5 dB	< -45.0 dB	< -72.7 dB	< -62.5 dB	< -71.5 dB	< -55.6 dB	< -71.5 dB	< -56.0 dB
SFDR (typ), excl harm.	> 85.5 dB	> 72.0 dB	> 60.0 dB	> 81.5 dB	> 68.5 dB	> 82.8 dB	> 66.5 dB	> 72.0 dB	> 67.0 dB

Dynamic parameters are measured at the given output level and 50 Ohm termination with a high resolution data acquisition card and are calculated from the spectrum. The sample rate that is selected is the maximum possible one. All available channels are activated for the tests. SNR and SFDR figures may differ depending on the quality of the used PC. SNR = Signal to Noise Ratio, THD = Total Harmonic Distortion, SFDR = Spurious Free Dynamic Range

Hardware block diagram

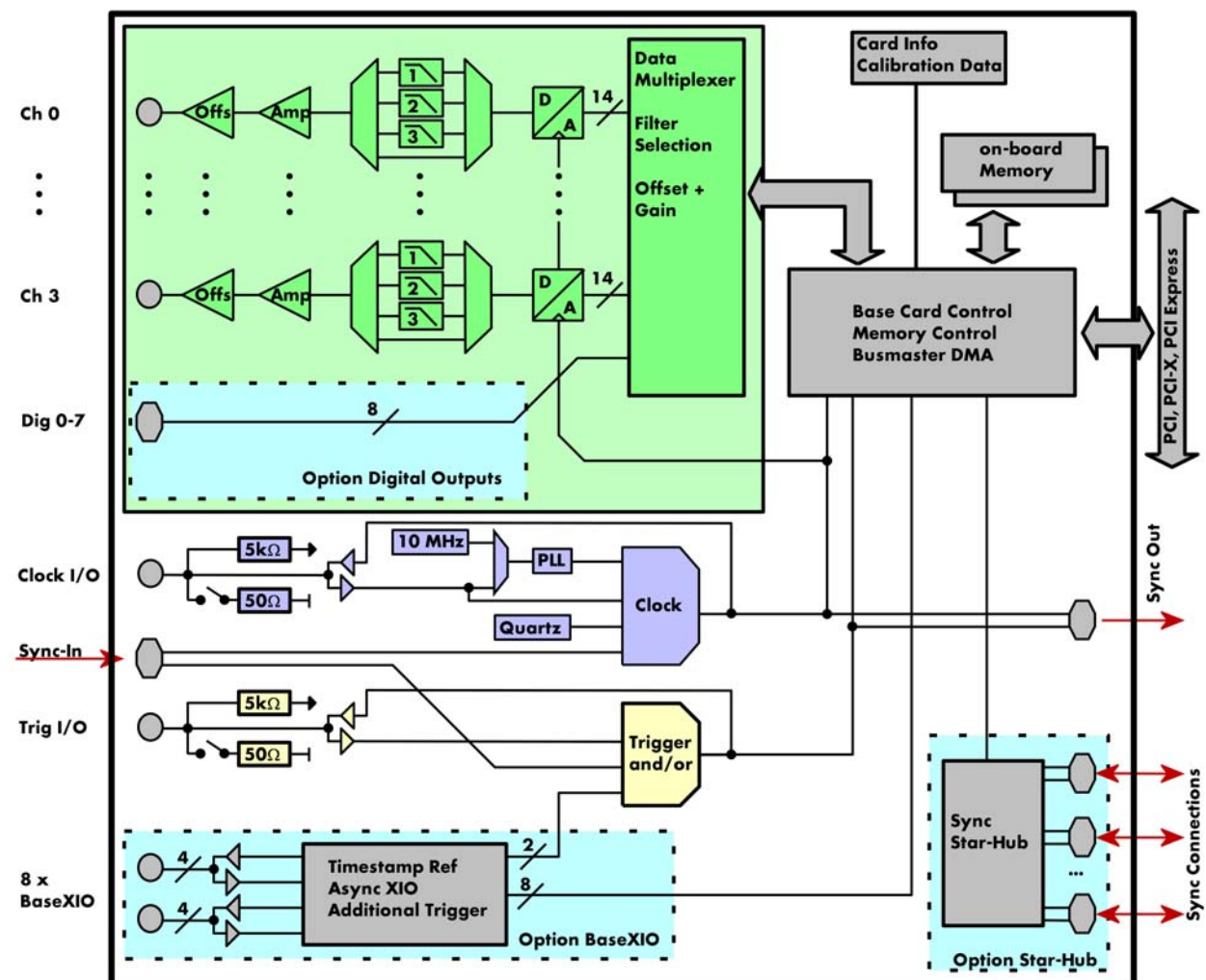

Order Information

PCI/PCI-X	Order no.	Standard mem	1 channel	2 channels	4 channels
	M2i.6011	128 MSample	20 MS/s	20 MS/s	
	M2i.6012	128 MSample	20 MS/s	20 MS/s	20 MS/s
	M2i.6021	128 MSample	60 MS/s	60 MS/s	
	M2i.6022	128 MSample	60 MS/s	60 MS/s	60 MS/s
	M2i.6030	128 MSample	125 MS/s		
	M2i.6031	128 MSample	125 MS/s	125 MS/s	
	M2i.6033	128 MSample	125 MS/s	60 MS/s	
	M2i.6034	128 MSample	125 MS/s	125 MS/s	60 MS/s
PCI Express	Order no.	Standard mem	1 channel	2 channels	4 channels
	M2i.6011-exp	128 MSample	20 MS/s	20 MS/s	
	M2i.6012-exp	128 MSample	20 MS/s	20 MS/s	20 MS/s
	M2i.6021-exp	128 MSample	60 MS/s	60 MS/s	
	M2i.6022-exp	128 MSample	60 MS/s	60 MS/s	60 MS/s
	M2i.6030-exp	128 MSample	125 MS/s		
	M2i.6031-exp	128 MSample	125 MS/s	125 MS/s	
	M2i.6033-exp	128 MSample	125 MS/s	60 MS/s	
	M2i.6034-exp	128 MSample	125 MS/s	125 MS/s	60 MS/s
Memory	Order no.	Option			
	M2i.xxxx-256MS	Memory upgrade to 256 MSample (512 MB) total memory			
	M2i.xxxx-512MS	Memory upgrade to 512 MSample (1 GB) total memory			
	M2i.xxxx-1GS	Memory upgrade to 1 GSsample (2 GB) total memory			
	M2i.xxxx-2GS	Memory upgrade to 2 GSsample (4 GB) total memory			
Options	Order no.	Option			
	M2i.xxxx-mr	Option Multiple Replay			
	M2i.xxxx-gs	Option Gated Replay			
	M2i.xxxx-seq	Option Output Sequence Mode: output segments of different length with sequence control, programmed loops, trigger/software steps and online segment selection.			
	M2i.60xx-dig	Additional synchronous digital outputs (2 per analog channel) including Cab-d40-idx-100			
	M2i.xxxx-SH5 (1)	Synchronization Star-Hub for up to 5 cards, only 1 slot width			
	M2i.xxxx-SH16 (1)	Synchronization Star-Hub for up to 16 cards			
	M2i.xxxx-SSHM (1)	System-Star-Hub Master for up to 15 cards in the system and up to 17 systems, sync cables included			
	M2i.xxxx-SSH5 (1)	System-Star-Hub Slave for up to 5 cards in one system, all sync cables included			
	M2i.xxxx-SSH16 (1)	System-Star-Hub Slave for up to 16 cards in one system, all sync cables included			
	Ml.6xxx-1Amp	±10 V output amplifier card with 1 channel including SMB to SMB connection cable			
	Ml.6xxx-2Amp	±10 V output amplifier card with 2 channels including SMB to SMB connection cables			
	Ml.6xxx-4Amp	±10 V output amplifier card with 4 channels including SMB to SMB connection cables			
	M2i.xxxx-bxio	Option BaseXIO: 8 digital I/O lines usable as asynchronous I/O and additional external trigger lines, additional bracket with 8 SMB connectors			
	M2i-upgrade	Upgrade for M2i.xxxx: later installation of option -dig or -bxio			
Cables	Order no.	Option			
	Cab-3f-9m-80	Adapter cable SMB female to BNC male, 80 cm			
	Cab-3f-9f-80	Adapter cable SMB female to BNC female, 80 cm			
	Cab-3f-3f-80	Adapter cable SMB female to SMB female, 80 cm			
	Cab-3f-9m-200	Adapter cable SMB female to BNC male, 200 cm			
	Cab-3f-9f-200	Adapter cable SMB female to BNC female, 200 cm			
	Cab-3f-3f-200	Adapter cable SMB female to SMB female, 200 cm			
	Cab-3f-9f-5	Adapter cable SMB female to BNC female, 5 cm (short cable especially for oscilloscopes probes)			
	Cab-d40-idx-100	Flat ribbon cable 40 pole FX2 for digital connector to 2x20 pole IDC connector, 100 cm			
	Cab-d40-d40-100	Flat ribbon cable 40 pole FX2 for digital connector to 40 pole digital FX2 connector, 100 cm			
Drivers	Order no.	Option			
	M2i.xxxx-ml	MATLAB driver for all M2i and M2i Express cards			
	M2i.xxxx-lv	LabVIEW driver for all M2i and M2i Express cards			
	M2i.60xx-dl	DASyLab driver for all M2i.60xx cards			
	M2i.60xx-vee	Agilent VEE driver for all M2i.60xx cards			
SBench6	Order no.	Option			
	SBench6	Base version which support standard mode for one card			
	SBench6-Pro	Professional version for one card: FIFO mode, export/import, calculation functions			
	SBench6-Multi	Option multiple cards: needs Professional version. Handles multiple synchronized cards in one system.			
	Volume Licenses	Please ask Spectrum for details.			

(1) : Just one of the options can be installed on a card at a time.

(2) : Third party product with warranty differing from our export conditions. No volume rebate possible.

Technical changes and printing errors possible