



# SPECTRUM

SYSTEMENTWICKLUNG MICROELECTRONIC GMBH

## **M2i.47xx - 16 channel 16 bit A/D up to 1.33 MS/s**

- 8 or 16 channels with 100 kS/s up to 1.33 MS/s
- Simultaneously sampling on all channels
- Separate ADC and amplifier per channel
- Complete on-board calibration
- 8 input ranges:  $\pm 50$  mV up to  $\pm 10$  V
- Up to 2 GSample (4 GByte) on-board memory
- 128 MSample standard memory installed
- Window, pulse width, re-arm, spike trigger
- OR/AND trigger combinations
- Synchronization of up to 16 cards per system and up to 271 cards with system sync
- Options: ABA mode, Multiple Recording, Gated Sampling, BaseXIO



PCI / PCI-X

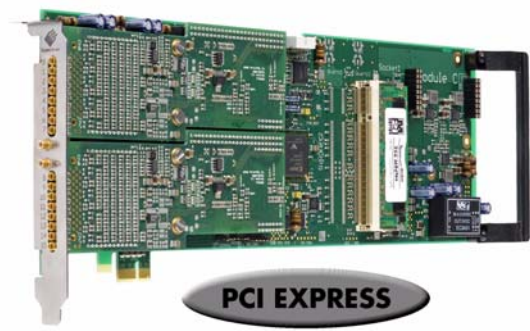

PCI EXPRESS

- 66 MHz 32 bit PCI-X interface
- 5V / 3.3V PCI compatible
- 100% compatible to conventional PCI > V2.1
- Sustained streaming mode up to 245 MB/s

- 2,5 GBit x1 PCIe Interface
- Works with x1/x4/x8/x16\* PCIe slots
- Software compatible to PCI
- Sustained streaming mode up to 160 MB/s

<b><u>Operating Systems</u></b>	<b><u>Recommended Software</u></b>	<b><u>Drivers</u></b>
<ul style="list-style-type: none"> <li>• Windows 2k, XP, Vista, 7</li> <li>• Linux Kernel 2.4 + 2.6</li> <li>• Windows/Linux 32 and 64 bit</li> </ul>	<ul style="list-style-type: none"> <li>• Visual Basic, Visual C++, Borland C++ Builder, GNU C++, Borland Delphi, .VB.NET, C#, J#, Python</li> <li>• SBench 6</li> </ul>	<ul style="list-style-type: none"> <li>• MATLAB</li> <li>• LabVIEW, LabWindows</li> <li>• DASYLab</li> <li>• Agilent VEE</li> </ul>

<b>Model</b>	<b>1 channel</b>	<b>2 channel</b>	<b>4 channel</b>	<b>8 channel</b>	<b>16 channel</b>
M2i.4710	100 kS/s	100 kS/s	100 kS/s	100 kS/s	
M2i.4711	100 kS/s	100 kS/s	100 kS/s	100 kS/s	100 kS/s
M2i.4720	250 kS/s	250 kS/s	250 kS/s	250 kS/s	
M2i.4721	250 kS/s	250 kS/s	250 kS/s	250 kS/s	250 kS/s
M2i.4730	500 kS/s	500 kS/s	500 kS/s	500 kS/s	
M2i.4731	500 kS/s	500 kS/s	500 kS/s	500 kS/s	500 kS/s
M2i.4740	1.33 MS/s	1.33 MS/s	1.33 MS/s	1.33 MS/s	
M2i.4741	1.33 MS/s	1.33 MS/s	1.33 MS/s	1.33 MS/s	1.33 MS/s

### **General Information**

The M2i.47xx series allows recording of one, two, four, eight or sixteen channels with sampling rates of 100 kS/s up to 1.33 MS/s. These cards offer outstanding A/D features both in resolution and speed for PCI/PCI-X and PCI Express. They are available in several versions and different speed grades making it possible for the user to find an individual solution. The installed memory of up to 2 GSample can be used for fast data recording or sustained data streaming. The enhanced FIFO engine is capable of streaming even 16 channels with 1.33 MS/s sustained to memory or hard disk.

\*Some x16 PCIe slots are for the use of graphic cards only and can not be used for other cards.

## Software Support

### Windows drivers

The cards are delivered with drivers for Windows 2000, XP, XP64, Vista and Vista64 as well as Windows 7. Programming examples for Visual C++, Borland C++ Builder, LabWindows/CVI, Borland Delphi, Visual Basic, VB.NET, C# and J# are included.

### Linux Drivers



All cards are delivered with full Linux support. Pre compiled kernel modules are included for the most common distributions like RedHat, Fedora, Suse or Debian. The Linux support includes SMP systems, 32 bit and 64 bit systems, versatile programming examples for Gnu C++ as well as the possibility to get the driver sources for own compilation.

### SBench 6

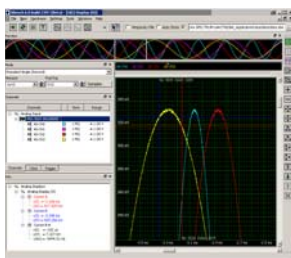

A base licence of SBench 6 the easy-to-use graphical operating software for the Spectrum cards is included in the delivery. Using the base license it is possible to test the card and to show acquired data. There are also some basic measurement functions included in the base license. The card comes with a demo license for the professional

version giving the user the opportunity to test the features of the professional version with the new hardware. Existing customers have the opportunity to request a demo license for the professional version at Spectrum. The professional version contains several new measurement functions, FFT, import and export (including MATLAB and ASCII) as well as the streaming modes. The data streaming modes allow to continuously acquire data to hard disk. SBench 6 has been optimized to handle data files of several GByte. More details on SBench 6 are found in the dedicated SBench 6 data sheet. The version 6 is running under Windows as well as under Linux (KDE and GNOME). A test version of SBench 6 is freely available in the internet. This test version will also operate with demo cards and can be tested as Professional version without any hardware installed.

### Third-party products

A lot of third-party products are supported as an option. Choose between LabVIEW, MATLAB, DASYLab and Agilent VEE. All drivers come with examples and detailed documentation.

### MI Software compatibility layer

To allow an easy change from MI cards to the new M2i cards for existing software a special software compatibility layer is delivered with the cards. This DLL converts MI calls to M2i calls and simulates a MI card in the software.

## Hardware features and options

### PCI/PCI-X



The cards with PCI/PCI-X bus connector use 32 Bit and up to 66 MHz clock rate for data transfer. They are 100% compatible to Conventional PCI > V2.1. The universal interface allows the use in PCI slots with 5 V I/O and 3.3 V I/O voltages as well as in PCI-

X or PCI 64 slots. The maximum sustained data transfer rate is 245 MByte/s per bus segment.

### PCI Express



The cards with PCI Express use a x1 PCIe connector. They can be used in PCI Express x1/x4/x8/x16 slots, except special graphic card slots, and are 100% software compatible to Conventional PCI > V2.1. The maximum sustained data transfer rate is

160 MByte/s per slot.

### Input Amplifier

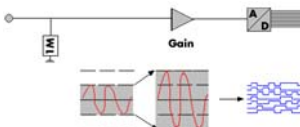

The analog inputs can easily be adapted to real world signals using settings that are individual for each channel. By using software commands one can select a matching input range.

### Ring buffer mode

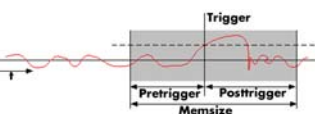

The ring buffer mode is the standard mode of all oscilloscope boards. Data is written in a ring memory of the board until a trigger event is detected. After the event the posttrigger values are recorded. Because of this continuously recording into a ring buffer there are also samples prior to the trigger event visible: Pretrigger = Memsize - Posttrigger.

### FIFO mode

The FIFO mode is designed for continuous data transfer between measurement board and PC memory (up to 245 MB/s on a PCI-X slot, up to 125 MB/s on a PCI slot and up to 160 MB/s on a PCIe slot) or hard disk. The control of the data stream is done automatically by the driver on interrupt request. The complete installed on-board memory is used for buffer data, making the continuous streaming extremely reliable.

### Channel trigger

The data acquisition boards offer a wide variety of trigger modes. Besides the standard signal checking for level and edge as known from oscilloscopes it's also possible to define a window trigger. All trigger modes can be combined with the pulsewidth trigger. This makes it possible to trigger on signal errors like too long or too short pulses. In addition to this a re-arming mode (for accurate trigger recognition on noisy signals) the AND/OR conjunction of different trigger events is possible. As a unique feature it is possible to use deactivated channels as trigger sources.

### External trigger I/O

All boards can be triggered using an external TTL signal. It's possible to use positive or negative edge also in combination with a programmable pulse width. An internally recognised trigger event can - when activated by software - be routed to the trigger connector to start external instruments.

### Pulse width

Defines the minimum or maximum width that a trigger pulse must have to generate a trigger event. Pulse width can be combined with channel trigger, pattern trigger and external trigger.

### Multiple Recording

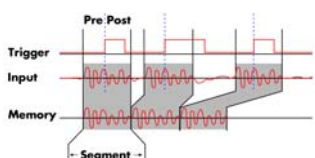

The Multiple Recording option allows the recording of several trigger events with an extremely short re-arming time. The hardware doesn't need to be restarted in be-

tween. The on-board memory is divided in several segments of the same size. Each of them is filled with data if a trigger event occurs. Pre- and posttrigger of the segments can be programmed. The number of acquired segments is only limited by the used memory and is unlimited when using FIFO mode.

### **Gated Sampling**

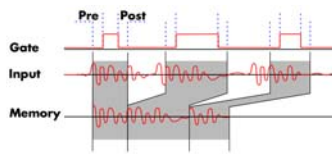

The Gated Sampling option allows data recording controlled by an external gate signal. Data is only recorded if the gate signal has a programmed level. In addition a pre-area before start

of the gate signal as well as a post area after end of the gate signal can be acquired. The number of gate segments is only limited by the used memory and is unlimited when using FIFO mode.

### **Timestamp**

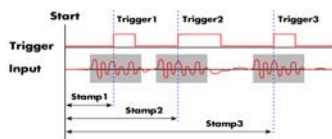

The timestamp option writes the time positions of the trigger events in an extra memory. The timestamps are relative to the start of recording, a defined zero time, externally synchronised to a radio clock, or a GPS receiver. With this option acquisitions of systems on different locations can be set in a precise time relation.

externally synchronised to a radio clock, or a GPS receiver. With this option acquisitions of systems on different locations can be set in a precise time relation.

### **External clock I/O**

Using a dedicated connector a sampling clock can be fed in from an external system. It's also possible to output the internally used sampling clock to synchronise external equipment to this clock.

### **ABA mode**

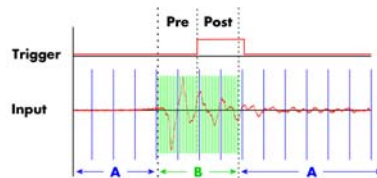

The optional ABA mode combines slow continuous data recording with fast acquisition on trigger events. The ABA mode works like a slow data logger combined with a fast digitizer. The

exact position of the trigger events is stored as timestamps in an extra memory.

### **Reference clock**

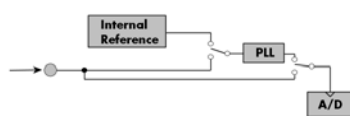

The option to use a precise external reference clock (normally 10 MHz) is necessary to synchronize the board for high-quality measurements with external equipment (like a signal source). It's also possible to enhance the quality of the sampling clock in this way. The driver automatically generates the requested sampling clock from the fed in reference clock.

It's also possible to enhance the quality of the sampling clock in this way. The driver automatically generates the requested sampling clock from the fed in reference clock.

### **BaseXIO (enhanced trigger)**



The BaseXIO option offers 8 asynchronous digital I/O lines on the base card. The direction can be selected by software in groups of four. Two of these lines can also be used as additional external trigger sources. This allows the building of complex trigger conjunctions with external gated triggers as well as AND/OR conjunction of multiple external trigger sources like, for example, the picture and row synchronisation of video signals. In addition one of the I/O lines can be used as reference clock for the Timestamp counter.

### **Star-Hub**



The star-hub is an additional module allowing the phase stable synchronisation of up to 16 boards in one system. Independent of the number of boards there is no phase delay between all channels. The star-hub distributes trigger and

clock information between all boards. As a result all connected boards are running with the same clock and the same trigger. All trigger sources can be combined with OR/AND allowing all channels of all cards to be trigger source at the same time. The star-hub is available as 5 card and 16 card version. The 5 card version doesn't need an extra slot.

### **271 synchronous cards with the System Star-Hub**

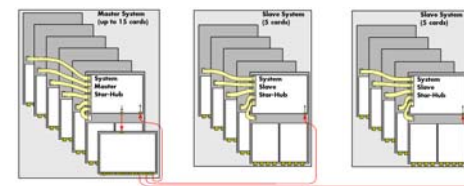

With the help of multiple system star-hubs it is possible to link up to 17 system phase synchronous with each other.

Each system can then contain up to 16 cards (master only 15). In total 271 cards can be used fully synchronously in a bunch of systems. One master system distributes clock and trigger signal to all connected slave systems.

## Technical Data

### Analog Inputs

Resolution	16 bit ( $\pm 32000$ values)
Differential non linearity (DNL)	$\pm 1$ LSB (ADC)
Integral non linearity (INL)	$\pm 3$ LSB (ADC)
Offset error (full speed)	$\leq 0.1\%$ of range (after warm-up and calibration)
Gain error (full speed)	$\leq 0.1\%$ (after warm-up and calibration)
Fixed input mode	bipolar
Crosstalk: all ranges 100 kHz signal	-100 dB
Analog Input impedance	1 MOhm against GND
Over voltage protection	$\pm 30$ V all ranges (activated card)
Aliasing filter	2nd order, -3 dB point at card bandwidth
Connector (analog)	MMCX female
Connector (trigger/clock)	3 mm SMB male

### Trigger

Multi, Gate: re-arming time	< 4 samples
Max Pretrigger at Multi, Gate, FIFO	8176 Samples as sum of all active channels
Internal/External trigger accuracy	1 Sample
Channel trigger resolution	14 bit
Trigger output delay	One positive edge after internal trigger event
External trigger type	3.3V LVTTTL compatible (5V tolerant)
External trigger input	Low $\leq 0.8$ V, High $\geq 2.0$ V, $\geq 8$ ns in pulse stretch mode, $\geq 2$ clock periods all other modes
External trigger maximum voltage	-0.5 V up to +5.7 V (internally clamped to 5.0V, 100 mA max. clamping current)
External trigger output levels	Low $\leq 0.4$ V, High $\geq 2.4$ V, TTL compatible
External trigger output drive strength	Capable of driving 50 ohm load

### BaseXIO (Option)

BaseXIO Connector (extra bracket)	8 x SMB (8 x MMCX internal)
BaseXIO input	TTL compatible: Low $\leq 0.8$ V, High $\geq 2.0$ V
BaseXIO input impedance	4.7 kOhm towards 3.3 V
BaseXIO input maximum voltage	-0.5 V up to +5.5 V
BaseXIO output levels	TTL compatible: Low $\leq 0.4$ V, High $\geq 2.4$ V
BaseXIO output drive strength	32 mA maximum current

Power consumption (max speed)	PCI / PCI-X		PCI EXPRESS	
	3,3 V	5 V	3,3 V	12 V
M2i.47x0 (128 MS mem), open inputs	1.7 A	1.0 A	0.4 A	1.0 A
M2i.47x1 (128 MS mem), open inputs	1.7 A	2.0 A	0.4 A	1.4 A
M2i.47x1 (128 MS mem), 1.0 V DC input	1.7 A	3.6 A	0.4 A	1.6 A
M2i.4741 (2 GS memory), open inputs	2.8 A	2.0 A	0.4 A	2.2 A

Max channels with Star-Hub	SH5	SH16	SSH55	SSH16
M2i.47x0	40	128	680	2168
M2i.47x1	80	256	1360	4336

### PCI / PCI-X specific details

PCI / PCI-X bus slot type	32 bit 33/66 MHz
PCI / PCI-X bus slot compatibility	32/64 bit, 33-133 MHz, 3,3 V and 5 V I/O

### PCI EXPRESS specific details

PCIe slot type	x1
PCIe slot compatibility	x1/x4/x8/x16*

\*Some x16 PCIe slots are for graphic cards only and can not be used for other cards.

### Certifications, Compliances, Warranty

EMC Immunity	Compliant with CE Mark
EMC Emission	Compliant with CE Mark
Product warranty	2 years starting with the day of delivery
Software and firmware updates	Life-time, free of charge
MTBF	80000 hours

### Clock

Internal clock range (PLL mode)	1 kS/s to max (see table below)
Internal clock accuracy	$\leq 20$ ppm
Internal clock: max. jitter in PLL mode	TBD
Internal clock: max. jitter in quartz mode	TBD
Internal clock setup granularity	$\leq 1\%$ of range (100M, 10M, 1M, 100k,...)
Internal clock setup granularity example	range 1M to 10M: stepsize $\leq 100k$
Reference clock: external clock range	$\geq 1.0$ MHz and $\leq 125.0$ MHz
External clock range	DC to max (see table below)
External clock delay to internal clock	5.4 ns
External clock type	3.3V LVTTTL compatible
External clock input	Low $\leq 0.8$ V, High $\geq 2.0$ V, duty 45% - 55%
External clock maximum voltage	-0.5 V up to +3.8 V (internally clamped to 3.3V, 100 mA max. clamping current)
External clock output levels	Low $\leq 0.4$ V, High $\geq 2.4$ V, TTL compatible
External clock output drive strength	Capable of driving 50 ohm load

### Environmental and Physical details

Dimension (PCB only)	312 mm x 107 mm (full PCI length)
Width (Standard or star-hub 5)	1 full size slot
Width (star-hub 16)	2 full size slots
Weight (depending on options/channels)	290g (2/4 ch) up to 460g (8 ch + star-hub)
Warm up time	10 minutes
Operating temperature	0°C - 50°C
Storage temperature	-10°C - 70°C
Humidity	10% to 90%

### PCI / PCI-X specific details

PCI / PCI-X bus slot type	32 bit 33/66 MHz
PCI / PCI-X bus slot compatibility	32/64 bit, 33-133 MHz, 3,3 V and 5 V I/O

### PCI EXPRESS specific details

PCIe slot type	x1
PCIe slot compatibility	x1/x4/x8/x16*

\*Some x16 PCIe slots are for graphic cards only and can not be used for other cards.

### Software programmable parameters

Input Range	$\pm 50$ mV, $\pm 100$ mV, $\pm 250$ mV, $\pm 500$ mV, $\pm 1$ V, $\pm 2$ V, $\pm 5$ V, $\pm 10$ V
Clock mode	Int. PLL, int. quartz, ext. clock, ext. divided, ext. reference clock, sync
Clock impedance	50 Ohm / high impedance ( $> 4k\Omega$ )
Trigger impedance	50 Ohm / high impedance ( $> 4k\Omega$ )
Trigger mode	Channel, Extern, SW, Auto, Window, Pulse, Re-Arm, Or/And, Delay
Trigger level resolution	14 bit
Trigger edge	Rising edge, falling edge or both edges
Trigger pulse width	0 to [64k - 1] samples in steps of 1 sample
Trigger delay	0 to [64k - 1] samples in steps of 1 sample
Memory depth	8 up to [installed memory / number of active channels] in steps of 4
Posttrigger	4 up to [8G - 4] samples in steps of 4
Multiple Recording segment size	8 up to [installed memory / 2 / active channels] in steps of 4
Multi / Gated pretrigger	0 up to [8k samples / number of active channels - 16]
ABA clock divider	1 up to [64k - 1] in steps of 1
Synchronization clock divider	2 up to [8k - 2] in steps of 2
Channel selection	1, 2, 4, 8 or 16 channels

## Dynamic Parameters

Model (M2i.xxxx/M2i.xxxx-Exp)	Unit	4710	4711	4720	4721	4730	4731	4740	4741
max internal or external clock		100 kS/s		250 kS/s		500 kS/s		1.33 MS/s	
-3 dB bandwidth		>50 kHz		>125 kHz		>250 kHz		>250 kHz	
RMS zero noise level ( $\geq \pm 500$ mV)	LSB	< 0.7	< 0.8	< 0.8	< 0.9	< 0.9	< 1.0	TBD	TBD
RMS zero noise level ( $< \pm 500$ mV)	$\mu$ V	< 6	< 7	< 7	< 8	< 10	< 13	TBD	TBD
Test - sampling rate		100 kS/s		250 kS/s		500 kS/s		1.33 MS/s	
Test signal frequency		10 kHz		10 kHz		10 kHz		10 kHz	
SNR (typ)	dB	91.5	91.2	90.6	90.5	88.7	88.5	89.4	89.2
THD (typ)	dB	-101.3	-101.2	-100.5	-100.5	-92.5	-92.5	-101.6	-101.4
SFDR (typ), excl. harm.	dB	108.8	108.9	106.7	106.8	104.5	104.3	106.0	105.8
ENOB (based on SNR)	bit	14.9	14.8	14.7	14.7	14.4	14.4	14.5	14.5
ENOB (based on SINAD)	bit	14.7	14.6	14.6	14.6	14.3	14.2	14.4	14.4

Dynamic parameters are measured at  $\pm 5$  V input range (if no other range is stated) and 1 M $\Omega$  termination with the sampling rate specified in the table. Measured parameters are averaged 20 times to get typical values. Test signal is a pure sine wave of the specified frequency with  $> 99\%$  amplitude. SNR and RMS noise parameters may differ depending on the quality of the used PC. SNR = Signal to Noise Ratio, THD = Total Harmonic Distortion, SFDR = Spurious Free Dynamic Range, SINAD = Signal Noise and Distortion, ENOB = Effective Number of Bits. For a detailed description please see application note 002.

## Hardware block diagram

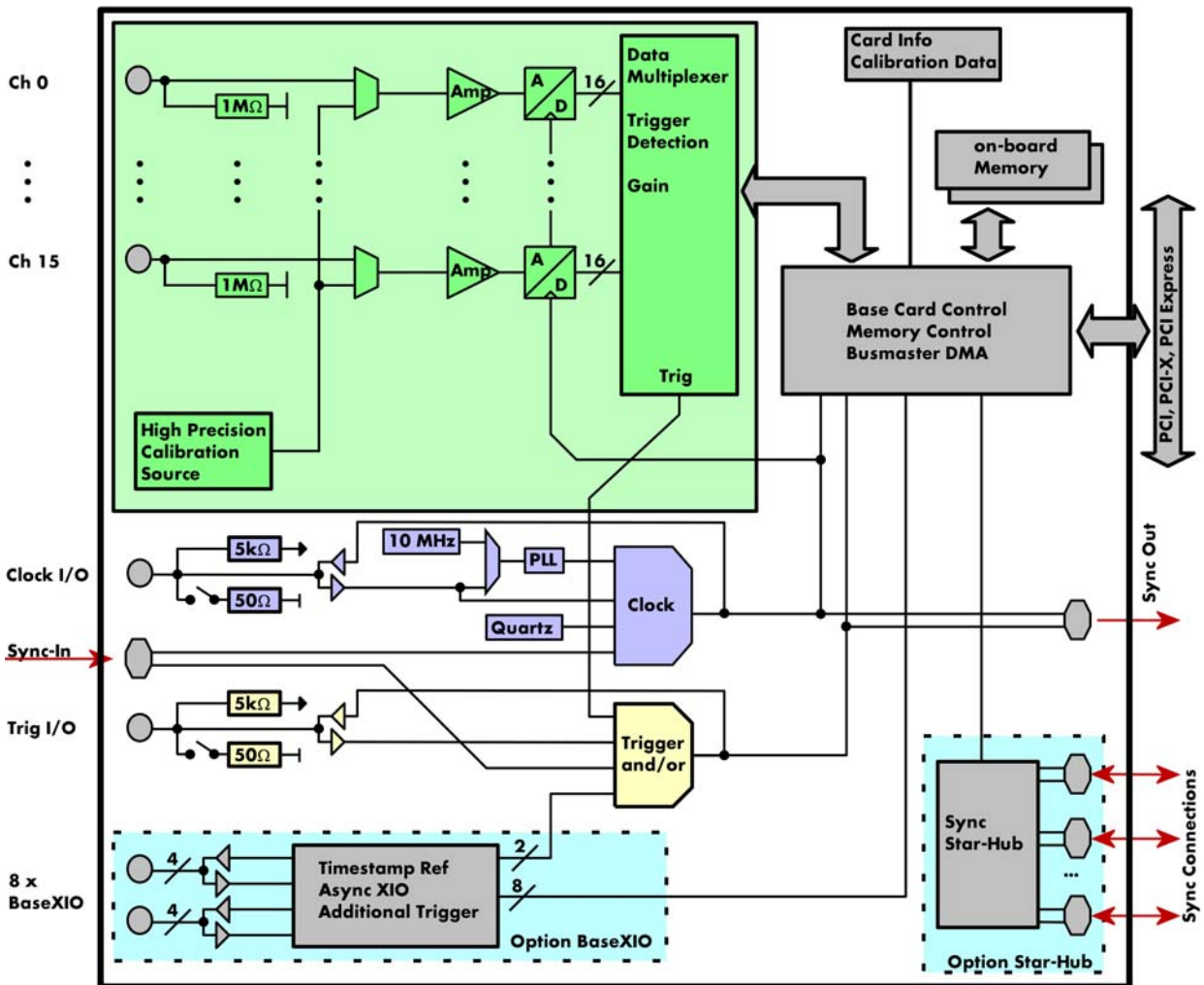

## Order Information

<b>PCI/PCI-X</b>	Order no.	Standard mem	1 channel	2 channels	4 channels	8 channels	16 channels	
	M2i.4710	128 MSample	100 kS/s	100 kS/s	100 kS/s	100 kS/s		
	M2i.4711	128 MSample	100 kS/s	100 kS/s	100 kS/s	100 kS/s	100 kS/s	
	M2i.4720	128 MSample	250 kS/s	250 kS/s	250 kS/s	250 kS/s		
	M2i.4721	128 MSample	250 kS/s	250 kS/s	250 kS/s	250 kS/s	250 kS/s	
	M2i.4730	128 MSample	500 kS/s	500 kS/s	500 kS/s	500 kS/s		
	M2i.4731	128 MSample	500 kS/s	500 kS/s	500 kS/s	500 kS/s	500 kS/s	
	M2i.4740	128 MSample	1.33 MS/s	1.33 MS/s	1.33 MS/s	1.33 MS/s		
	M2i.4741	128 MSample	1.33 MS/s	1.33 MS/s	1.33 MS/s	1.33 MS/s	1.33 MS/s	
<b>PCI Express</b>	Order no.	Standard mem	1 channel	2 channels	4 channels	8 channels	16 channels	
	M2i.4710-exp	128 MSample	100 kS/s	100 kS/s	100 kS/s	100 kS/s		
	M2i.4711-exp	128 MSample	100 kS/s	100 kS/s	100 kS/s	100 kS/s	100 kS/s	
	M2i.4720-exp	128 MSample	250 kS/s	250 kS/s	250 kS/s	250 kS/s		
	M2i.4721-exp	128 MSample	250 kS/s	250 kS/s	250 kS/s	250 kS/s	250 kS/s	
	M2i.4730-exp	128 MSample	500 kS/s	500 kS/s	500 kS/s	500 kS/s		
	M2i.4731-exp	128 MSample	500 kS/s	500 kS/s	500 kS/s	500 kS/s	500 kS/s	
	M2i.4740-exp	128 MSample	1.33 MS/s	1.33 MS/s	1.33 MS/s	1.33 MS/s		
	M2i.4741-exp	128 MSample	1.33 MS/s	1.33 MS/s	1.33 MS/s	1.33 MS/s	1.33 MS/s	
<b>Memory</b>	Order no.	Option						
	M2i.xxxx-256MS	Memory upgrade to 256 MSample (512 MB) total memory						
	M2i.xxxx-512MS	Memory upgrade to 512 MSample (1 GB) total memory						
	M2i.xxxx-1GS	Memory upgrade to 1 GSsample (2 GB) total memory						
	M2i.xxxx-2GS	Memory upgrade to 2 GSsample (4 GB) total memory						
<b>Options</b>	Order no.	Option						
	M2i.xxxx-mr	Option Multiple Recording						
	M2i.xxxx-mgt	Option pack including Multiple Recording, Gated Sampling, Timestamp						
	M2i.xxxx-mgtab	Option pack including Multiple Recording, Gated Sampling, Timestamp, ABA mode						
	M2i.xxxx-SHS (1)	Synchronization Star-Hub for up to 5 cards, only 1 slot width						
	M2i.xxxx-SH16 (1)	Synchronization Star-Hub for up to 16 cards						
	M2i.xxxx-SSHM (1)	System-Star-Hub Master for up to 15 cards in the system and up to 17 systems, sync cables included						
	M2i.xxxx-SSH5 (1)	System-Star-Hub Slave for up to 5 cards in one system, all sync cables included						
	M2i.xxxx-SSH516 (1)	System-Star-Hub Slave for up to 16 cards in one system, all sync cables included						
	M2i.xxxx-bxio	Option BaseXIO: 8 digital I/O lines usable as asynchronous I/O, timestamp ref-clock and additional external trigger lines, additional bracket with 8 SMB connectors						
	M2i-upgrade	Upgrade for M2i.xxxx: later installation of option-dig or -bxio						
<b>Cables</b>	Order no.	Option						
	Cab-1m-9m-80	Adapter cable MMCX male to BNC male, 80 cm (for analog inputs)						
	Cab-1m-9f-80	Adapter cable MMCX male to BNC female, 80 cm (for analog inputs)						
	Cab-1m-9m-200	Adapter cable MMCX male to BNC male, 200 cm (for analog inputs)						
	Cab-1m-9f-200	Adapter cable MMCX male to BNC female, 200 cm (for analog inputs)						
	Cab-1m-9f-5	Adapter cable MMCX male to BNC female, 5 cm (short cable especially for oscilloscope probes)						
	Cab-3f-9m-80	Adapter cable SMB female to BNC male, 80 cm (for clock and trigger I/O)						
	Cab-3f-9f-80	Adapter cable SMB female to BNC female, 80 cm (for clock and trigger I/O)						
	Cab-3f-3f-80	Adapter cable SMB female to SMB female, 80 cm (for clock and trigger I/O)						
	Cab-3f-9m-200	Adapter cable SMB female to BNC male, 200 cm (for clock and trigger I/O)						
	Cab-3f-9f-200	Adapter cable SMB female to BNC female, 200 cm (for clock and trigger I/O)						
	Cab-3f-3f-200	Adapter cable SMB female to SMB female, 200 cm (for clock and trigger I/O)						
<b>Drivers</b>	Order no.	Option						
	M2i.xxxx-ml	MATLAB driver for all M2i and M2i Express cards						
	M2i.xxxx-lv	LabVIEW driver for all M2i and M2i Express cards						
	M2i.47xx-dl	DASyLab driver for all M2i.47xx cards						
	M2i.47xx-vee	Agilent VEE driver for all M2i.47xx cards						
<b>SBench6</b>	Order no.	Option						
	SBench6	Base version which support standard mode for one card						
	SBench6-Pro	Professional version for one card: FIFO mode, export/import, calculation functions						
	SBench6-Multi	Option multiple cards: needs Professional version. Handles multiple synchronized cards in one system.						
	Volume Licenses	Please ask Spectrum for details.						

(1) : Just one of the options can be installed on a card at a time.

(2) : Third party product with warranty differing from our export conditions. No volume rebate possible.

**Technical changes and printing errors possible**