

▶ Product Note

Triggering and Synchronization in Modular Digitizers

Introduction

Digitizers are used to convert electrical signals into a series of measurements that are then output as a numerical array of amplitude values versus time. To make this information useful the time information is typically related to a specific reference point which is most commonly the trigger position. The trigger point can be something that occurs within the measured signal or it can be from other external sources. The function of triggering is to link the time measurements to a specific known point in time. For repetitive signals the trigger must be stable in order to enable measurements from one acquisition to be compared with others. When multiple digitizers or related acquisition instruments are integrated into a multi-channel system meaningful data can only be obtained when all channels are referenced to a common time axis. This requires time synchronization of the data acquisition elements of the system with all the digitizer channels normally being triggered by the same event. This application note will focus on the related topics of triggering and synchronization.

Triggering

Triggering is an essential function for any instrument that acquires and digitizes signals. The most common trigger method uses the signal that is input into one of the digitizers channels. The basic principle is that a defined point on the waveform is detected and this 'trigger event' is marked as a known position on the acquired data. Figure 1 provides an example of a basic edge trigger. The signal source is the input channel with the trigger event occurring when the waveform crosses the trigger level at 500mV with a positive slope. When this occurs, that position on the acquired signal is marked as the zero time point on the time axis as shown by the cursor position in the figure. If the signal is repetitive the digitizer will be triggered at the same point each time a new acquisition is made, resulting in a stable display.

The wide variation in possible signal waveforms, levels, and timing requires that the digitizers trigger circuit be extremely flexible. Figure 2 shows a block diagram of the trigger 'engine' of a Spectrum M4i series digitizer. This provides an example of the wide range of trigger conditions that are supported in modern digitizers.

The hardware trigger sources are shown on the left hand side of the block diagram. They include any of the input channels and either of the two external trigger inputs (Ext0 or Ext1). Each of these sources is capable of supporting multiple

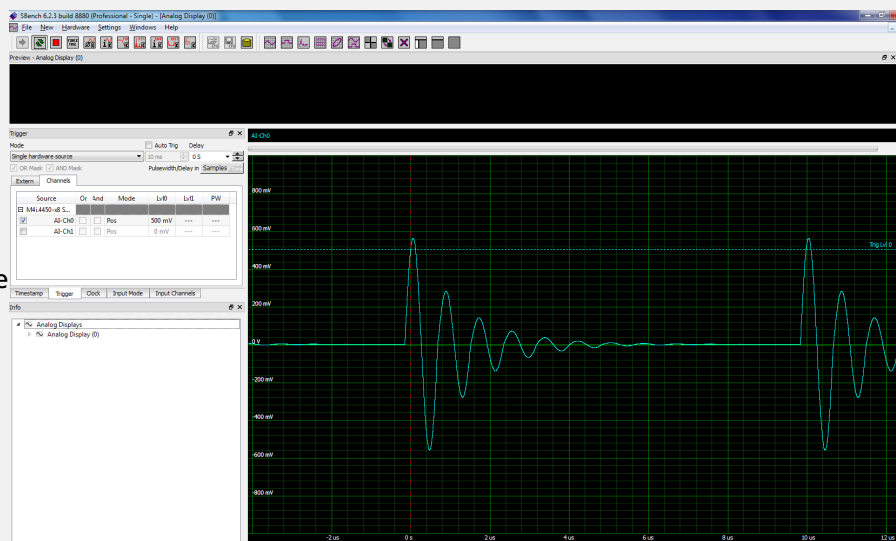

Figure 1: An example of a basic edge trigger defining the zero time value on the time axis (marked by the vertical dashed line). When the waveform crosses the trigger level (horizontal dashed line) with a positive slope.

► **Product Note**

trigger types. The multipurpose I/O lines can be used to report the digitizers run/arm state as well as to provide a trigger output signal among other functions. In addition to the hardware trigger sources there is also a software trigger which allows triggering under program control.

This digitizer also includes powerful trigger AND/OR logic elements that are used to combine inputs from multiple sources into a complex multi-element trigger. The functionality can be used to ensure the digitizer will only trigger when specifically defined patterns occur. Yet another feature is the ability to cross trigger with up to seven other digitizer cards via the Star-Hub synchronization option.

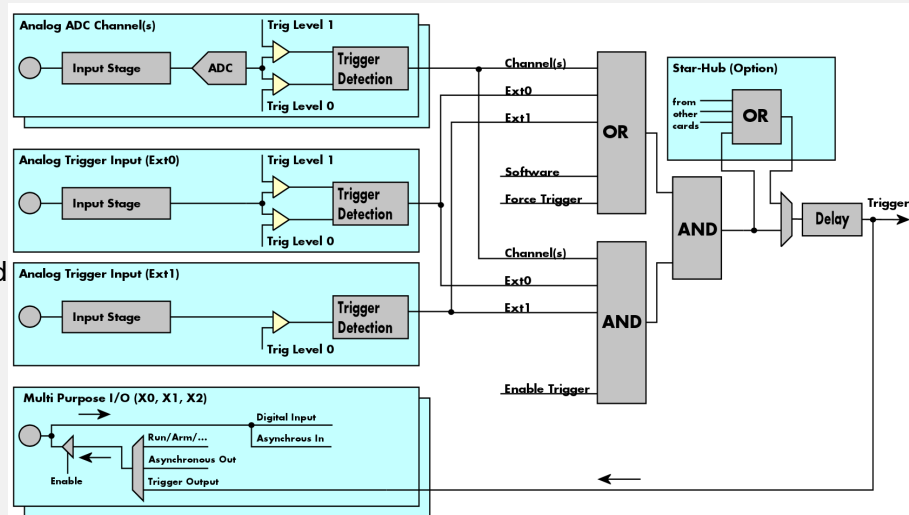

Figure 2: The block diagram of the 'Trigger Engine' of a Spectrum M4i series digitizer showing the trigger sources, and trigger logic for these general purpose digitizers..

Trigger Modes

The principal trigger sources contain dual trigger level comparators and support multiple trigger modes. These include single and dual slope edge triggers, re-arm (hysteresis) triggers, window triggers, and for the multiple source trigger there are related trigger gate generators.

Edge triggers are the most basic trigger type. The user sets a trigger level and selects the desired trigger slope. When the trigger source crosses the trigger threshold with the selected slope the digitizer triggers. The slope selection is positive, negative, or both. Edge trigger is the most commonly used trigger mode.

Re-arm or Hysteresis triggers set two levels, the first is the arm level the second is the trigger level. As with the edge trigger the user also selects a slope. The signal must cross the arm level with the selected slope first to arm the trigger. The digitizer will then only trigger when the signal subsequently crosses the trigger level with the same slope. The re-arm trigger modes can be used to prevent the digitizer from triggering on the wrong edges of noisy signals.

Window triggers use two trigger thresholds per trigger source to define an amplitude window. There are two operational modes for the window trigger; trigger upon entering the window and trigger upon exiting the window. Trigger on entering will trigger whenever the source signal crosses one of the threshold levels and enters the window. The trigger on exiting triggers when the source signal has been between the two trigger thresholds and then leaves the window. Window triggers are used when the source signal can change states in either direction.

When using a multi-source trigger mode with the built-in trigger logic it is often necessary to use one channel to create a gate waveform to enable a trigger from another channel. This can be done using the **hi level, low level, inside window, or outside window** selections. These trigger modes generate an internal gate signal that can be used together with a second trigger source and AND logic to gate the trigger. Figure 3 shows an example of using the high level trigger to gate a trigger source on another channel.

▶ **Product Note**

Whenever the sine wave on channel CH0 exceeds the trigger level a positive gate is generated for the entire time that the signal is above the threshold. This gate signal is AND'ed with the signal on channel CH1; since the gate signal is positive only while the low amplitude pulse is present on CH1 the digitizer triggers when the pulse waveform crosses the trigger level shown as a horizontal, red dashed line in the figure.

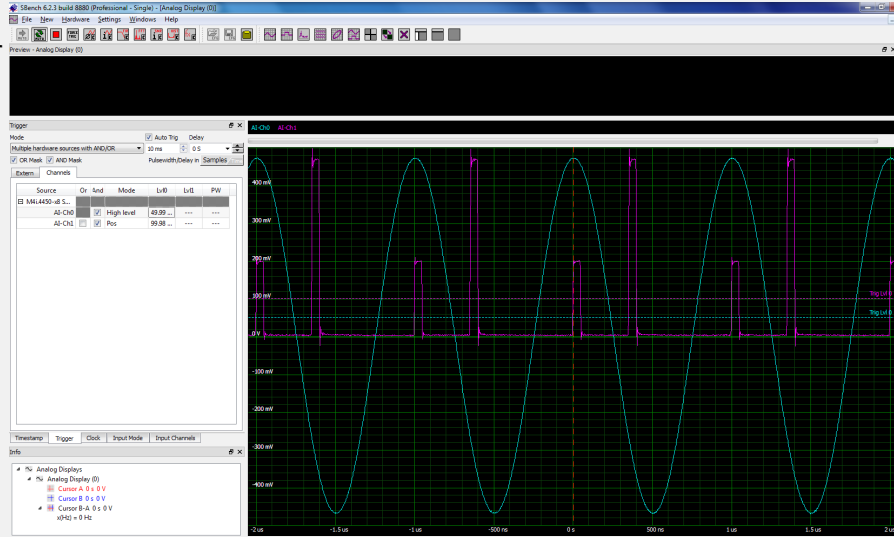
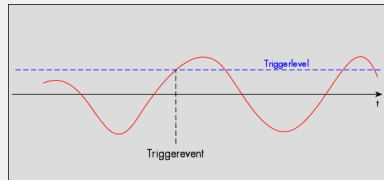
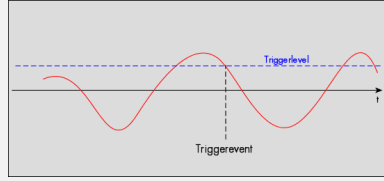
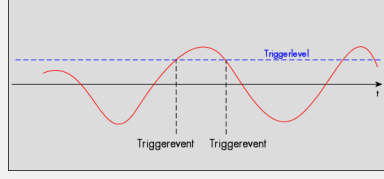

Figure 3: Use of the High Level trigger on CH0 to create a gate signal to select the lower of the two pulses on channel CH1. The Hi Level trigger creates a gate that is in a positive state as long as the trigger source is above the trigger level (Trig Lvl 0.). This gate is ANDed with the CH1 pulse waveform which allows the digitizer to trigger on the lower amplitude pulse.

Summary Table of M4i Series Modular Digitizer Trigger Modes

Table 1 contains a summary of each of the trigger modes available in Spectrum M4i digitizers

Mode Description	Diagram
<p>Positive Edge Trigger</p> <p>The trigger occurs if the trigger source signal goes from a lower value to higher values (positive slope or rising edge) crossing the predefined trigger level.</p>	
<p>Negative Edge Trigger</p> <p>The trigger occurs if the trigger source signal goes from a higher value to lower values (negative slope or falling edge) crossing the predefined trigger level.</p>	
<p>Dual Edge Trigger</p> <p>The trigger occurs if the programmed trigger level is crossed by the trigger source signal with either a rising or falling edge.</p>	

▶ **Product Note**

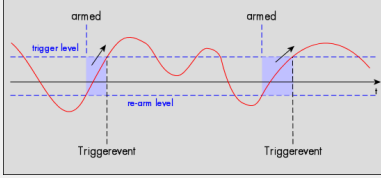
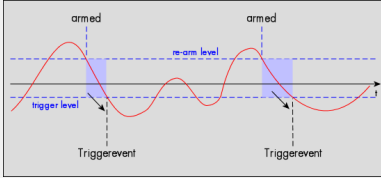
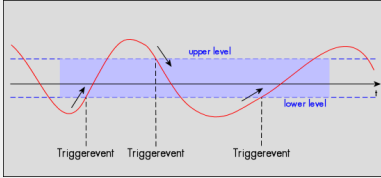
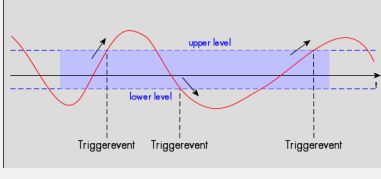
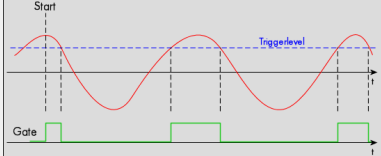
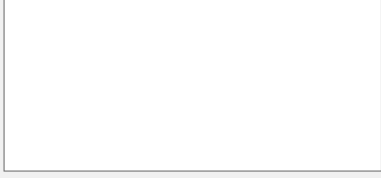
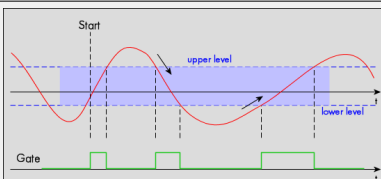
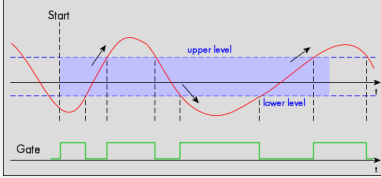
Mode Description	Diagram
<p>Re-arm (Hysteresis) trigger on positive edge</p> <p>The trigger circuit is armed when the source signal crosses the re-arm level with a positive slope. After arming, if the programmed trigger level is then crossed by the source signal with a rising edge, the trigger is generated and the trigger circuit will be disarmed. A new trigger event is only detected if the trigger engine is armed again.</p>	
<p>Re-arm trigger (Hysteresis) on negative edge</p> <p>The trigger circuit is armed when the source signal crosses the re-arm level with a negative slope. After arming, if the programmed trigger level is then crossed by the source signal with a falling edge, the trigger is generated and the trigger circuit will be disarmed. A new trigger event is only detected if the trigger engine is armed again.</p>	
<p>Channel window trigger for entering signals</p> <p>The upper and the lower level define an amplitude window. Every time the source signal enters the window from the outside, a trigger is generated.</p>	
<p>Channel window trigger for exiting signals</p> <p>The upper and the lower level define an amplitude window. Every time the signal leaves the window from the inside, a trigger is generated.</p>	
<p>High level trigger</p> <p>This mode generates an internal gate signal that can be used together with a second trigger mode to gate the trigger. If using this mode with a single trigger source then the card only triggers when the source signal exceeds the trigger level (acting like positive edge trigger).</p>	
<p>Low level trigger</p> <p>This mode generates an internal gate signal that can be used together with a second trigger mode to gate the trigger. If using this mode with a single trigger source then the card only triggers when the source signal is below the trigger level (acting like negative edge trigger).</p>	
<p>Inside window trigger</p> <p>This trigger mode will generate an internal gate signal that can be used together with a second trigger mode to gate the trigger. If using this mode as a single trigger source then the card will only trigger when entering the window defined by the two trigger levels (acting like window enter trigger).</p>	
<p>Outside window trigger</p> <p>This trigger mode will generate an internal gate signal that can be used together with a second trigger mode to gate the trigger. If using this mode as a single trigger source then the card will only trigger when leaving the window defined by the two trigger levels (acting like window exit trigger).</p>	

▶ **Product Note**

Trigger Logic.

The example in Figure 3 shows one use for the available trigger logic when dealing with multiple trigger sources. Both AND and OR logic elements are supported. Inputs to the OR function include any of the channels, the external trigger inputs, the software trigger and the force trigger function. The logical OR function permits any of these trigger sources to trigger the digitizer. Inputs to the AND logic function include all the channels, the external trigger inputs and the enable trigger function. The AND function requires that all selected trigger inputs be asserted at the same time in order to initiate a digitizer trigger. Keeping in mind that the gating trigger modes like hi level and low level provide the ability to logically invert inputs other logic such as NAND and NOR can be realized.

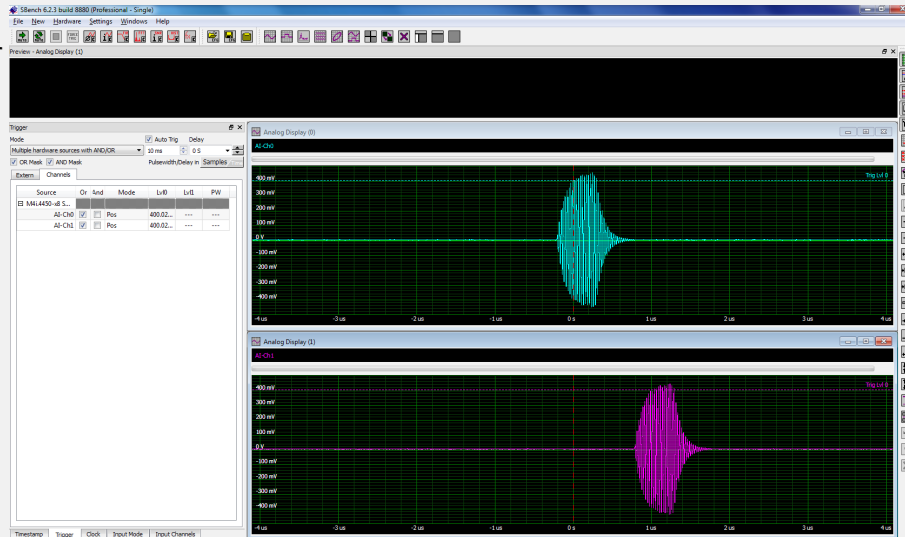

Figure 4: Use of OR trigger logic to trigger on the channel where the earliest RF burst occurs.

Figure 4 is an example of a radio location application that uses the OR trigger logic. Each of the input channels is connected to a sensor. Direction to the source is determined by the arrival time of the emitted pulse at each sensor.

The location of the source determines which channel sees it first. The OR trigger logic allows the channel with the earliest burst to trigger the digitizer, guaranteeing that both sensor outputs will be captured.

Another example of a multi-source trigger is shown in Figure 5. Here, two clock signals are compared. The low level trigger is setup on channel Ch0, which generates a gate positive signal when that channels amplitude is below the trigger level. Channel Ch1 triggers on the positive edge. Both trigger sources are AND'ed, which results in a trigger event when there is a missing pulse in Ch0. The missing pulse in Figure 5 appears at the trigger point (time=0).



Figure 5: Another example of using the AND trigger function with an inverted logic element (low Level mode on Ch0). This triggers when a missing pulse occurs in Ch0 compared with the pulse train on Ch1.

▶ **Product Note**

Other Trigger Related Features

There are two additional trigger functions that are worth mentioning. The first is trigger delay, which is the last element in the trigger block diagram in Figure 2. This function uses a 33 bit counter and allows the user to delay the trigger event up to 8 G– 16 samples in steps of 16 samples for the 14 and 16 bit M4i series digitizers used in

this article. If the delay is changed from the default zero setting then the trigger point on the horizontal axis is changed from zero to the delay valued entered.

The second feature is the external trigger output and trigger status lines. These features are useful in synchronizing multiple instruments. Trigger output, ARM and RUN status are available via the multipurpose I/O channels as diagrammed in Figure 2 above.

Synchronization

Theoretically, there are two issues when synchronizing instruments. The first is to arrange for a common trigger. The second is to have both instruments operate from a synchronized clock. As simple as this seems there are issues that arise when attempting to synchronize multiple digitizers.

The clock can be synchronized by using an external clock at the desired clock rate. A second method is to supply an external reference such as 10 MHz, this is then applied to a phase locked loop (PLL) which is used to multiply the frequency of the reference clock to the desired clock rate. The Spectrum M4i series digitizers used in this article handle both types of external clock through a common external clock input. The external clock input is connected to an internal PLL and this is set by the user to either multiply a reference clock or to phase lock to the external clock and pass it through without changing the frequency. This guarantees the correct frequency for the clock but does not guarantee that the clock in each digitizer has the identical phase.

On the trigger side of the synchronization process we have to consider that each digitizers external trigger input uses a separate comparator to detect the trigger level crossing. Small differences in reference level and differences in setup and hold times can result in discrete changes in the trigger point location in time, a form of trigger jitter.

The only way to guarantee exact synchronization of multiple digitizers is to distribute the clock to each module and to synchronize the trigger event to the system clock. In the Spectrum digitizers this can be done with the optional Star Hub module.

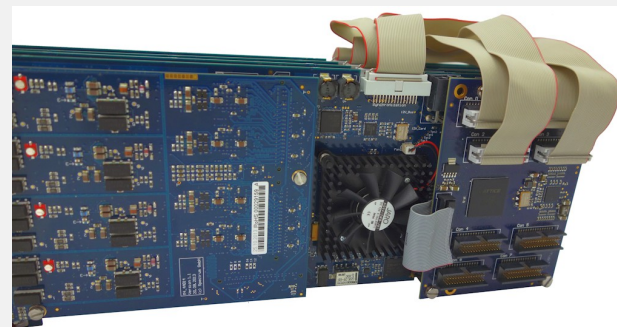

Figure 6: The optional Star Hub module shown synchronizing four digitizers. The module acts as a star connected hub for clock and trigger signals.

Synchronizing multiple digitizers

The Spectrum M4i series digitizer used in the examples in this article also has an optional synchronization accessory called Star Hub. The star hub module allows the synchronization of up to 8 cards of the same family. A photograph of the Star Hub is shown in Figure 6.

The module acts as a star connected hub for clock and trigger signals. The digitizer with the



▶ Product Note

module acts as the clock master and that card or any other card can be the trigger master. All the trigger modes that are available on the master card are also available if the star-hub module is used. It also expands the AND/OR trigger logic to accommodate inputs from any of the attached digitizers. The star-hub also synchronizes different pre-trigger, memory segment size and post trigger settings among digitizers by synchronizing the ARM signals from the digitizers. The Star Hub is the preferred method for synchronizing multiple digitizers.

Conclusion.

Digitizers require a trigger in order to relate the acquisition to a known point in time. Multiple trigger sources and modes make it easy to select the desired trigger point. Additionally, the ability to synchronize the time base via the Star-Hub allows multiple instruments to be coupled together offering a large number of acquisition channels.

Digitizers with smart trigger engines make it possible to trigger on and capture a wide variety of complex signals. This feature is further enhanced when combined with innovative acquisition modes such as ring buffer, FIFO, memory segmentation and gated sampling with time stamps marking trigger events. For additional information concerning the use of digitizer acquisition modes see the application note titled "Modular Digitizer Acquisition Modes" (<http://spectrum-instrumentation.com/en/applications/using-modular-digitizer-acquisition-modes>).

Authors:

Arthur Pini Independent Consultant

Greg Tate Asian Business Manager, Spectrum GmbH

Oliver Rovini Technical Manager, Spectrum GmbH